



**1-800-779-2102**

Mon – Thurs: 8:00am - 5:00pm | Friday: 8:00am - 4:00pm CST

**INSPECT YOUR PRODUCT FOR DAMAGE & MISSING PARTS BEFORE PROCEEDING TO INSTALLATION**

**PROCEDURE FOR RETURNS OR MISSING HARDWARE**

-PLEASE CONTACT THE ORIGINAL POINT OF PURCHASE FOR:  
SHIPPING DAMAGE, RETURNS, OR WARRANTY CLAIMS

-CONTACT DEE ZEE DIRECTLY FOR MISSING PARTS OR HARDWARE

**WWW.DEEZEE.COM**

REGISTER YOUR PRODUCT ONLINE: [www.deezee.com/registration](http://www.deezee.com/registration)

VIEW INSTRUCTIONS ONLINE: [www.deezee.com/instructions](http://www.deezee.com/instructions)

---

**⚠️ WARNING:** Cancer and Reproductive Harm  
[www.P65Warnings.ca.gov](http://www.P65Warnings.ca.gov)

Operating, servicing, and maintaining a passenger vehicle can expose you to chemicals such as lead, phthalates, engine exhaust, and carbon monoxide that are known to the State of California cause cancer and birth defects or other reproductive harm. To minimize exposure, service your vehicle and its accessories in a well-vented area and wear gloves or wash your hands frequently.



## DEE ZEE, INC. WARRANTY AGREEMENT

Dee Zee, Inc. guarantees the original purchaser a limited lifetime warranty against manufacturer defects in materials, workmanship, and design under normal use, excluding damage resulting from road hazards such as gravel or other debris, product misuse, improper installation, impairments from accidents, product modifications, improper repairs, spills, vandalism, product neglect, or acts of God.

This warranty applies only to the original purchaser of new product(s) and is limited to the replacement of genuine Dee Zee products. Modification of any kind to Dee Zee products voids all warranty coverage. Warranty does not include electrical components, installation, cost of removal, labor, transportation costs, loss of use, inconvenience, or consequential damages.

## WARRANTY COVERAGE - MATERIALS & WORKMANSHIP

### LIMITED LIFETIME WARRANTY:

- STAINLESS STEEL: Side Steps, Grill Guards, Bull Bars, Bed Caps, and Side Rails
- ALUMINUM: Side Steps, Running Boards, Storage Boxes, Transfer Tanks, Bed Protection, Side Rails, Invis-A-Racks, and Cab Racks
- PLASTIC: Storage Boxes
- OTHER: Front and Rear Bumpers

### THREE-YEAR WARRANTY:

- POWDER-COATED / E-COATED STEEL: Side Steps, Running Boards, Storage Boxes, Transfer Tanks, Cab Racks, Sport Bar Ladder Racks, Cargo Carriers, Mounting Brackets (NX, Rough Step, and Bumper Guards only)
- OTHER: Tailgate Assist, Bed Mats, Floor Mats, Auxiliary Fuel Connection Kits, and All Products Not Otherwise Listed Individually

## WARRANTY COVERAGE – FINISH PROTECTION

The finish of all Dee Zee products is covered for one-year (1) from the date of purchase. Dee Zee products have a high quality finish that must be cared for and maintained like any other exposed finish on the vehicle. Protect the finish with non-abrasive automotive wax (e.g. Pure Carnauba) on a regular basis. Applying soaps, polishes, or waxes that contain an abrasive compound may scratch the finish and leave the exposed material susceptible to corrosion.

## WARRANTY COVERAGE – COMPONENT PARTS

Operational items such as shocks, latches, hinges, and wear items including, but not limited to, mud flaps, step pads, toolbox tray, end caps, hardware, seals, etc. have a one-year (1) warranty. Replacement component parts can be ordered via credit card (MasterCard or VISA) by calling 1-800-779-2102. All replacement parts are non-returnable and non-refundable.

## **GPI® FUEL PUMPS & ACCESSORIES**

All Great Plains Industries (GPI) products, including transfer tank pumps and fuel meters are covered by GPI's warranty policies. Dee Zee's warranty terms do not apply to GPI products. To submit a warranty claim, please contact GPI at 1-800-835-0113 or visit [www.gpi.net](http://www.gpi.net).

### **WARRANTY SUBMISSION PROCEDURE**

All warranty claims will be initiated at the place of purchase. The original purchaser will be required to present the original sales receipt with purchase date shown and provide photographs of the defect.

In the event the originally purchased product style is no longer available, Dee Zee will warranty the defective part with a current equivalent. If a comparable product is no longer available, the product would be returned to the store of purchase for a refund or the applicable cost difference can be paid to choose an alternate style.

### **DISCLAIMER**

All products are sold as appearance accessories and should not be relied upon as protection for the vehicle or its occupants in the event of an accident. Vehicles equipped with a supplemental restraints system (air bags) deployed by impact and collision avoidance systems should not be modified in any way. Always consult the vehicle manufacturer if you have any questions regarding supplemental restraint systems and sensors.

Buyer must accommodate front and rear sensors during product installation and assumes all risk should these be tampered, rerouted, severed, or disconnected. This includes disabling visual, audio, or vibration alerts into the cab. Buyer assumes all risk and responsibility for wiring any supplemental auxiliary lights.

Buyer assumes all risk, liability, and cost for the installation and use of Dee Zee products. Dee Zee, Inc. assumes no liability for injury, loss, incidental or consequential damages in the event of an accident.



Thank you for choosing Dee Zee to add function and accessorize your vehicle. Dee Zee has been a staple brand in the truck accessory market since 1977 and we hold a reputation of quality manufacturing based in America's Heartland. Our products are born through careful engineering and backed by industry leading warranty programs. We appreciate the opportunity to serve you and your vehicle!

**Review the instruction pages in their entirety to prepare the required tools**

**Warning:** Please check for wiring or other obstructions before drilling any holes in the vehicle. If it is necessary to drill any holes, Dee Zee recommends putting a sealant or rust inhibitory around all holes drilled into the body of the vehicle.

It is the sole responsibility of the vehicle owner to check for tire clearance. It is unlawful and dangerous to ride on any external vehicle step while the vehicle is in motion.

**Cleaning:** To be entitled to all warranty rights offered with the product, Dee Zee steps need to be cleaned regularly with a mild detergent. Do NOT use abrasive cleaners. For stainless steel products, the application of a high grade automotive wax is recommended.



Dee Zee Cares - Please Recycle







For an electronic version of these instructions visit: [www.deezee.com/instructions](http://www.deezee.com/instructions)

Register your product online: [www.deezee.com/registration](http://www.deezee.com/registration)

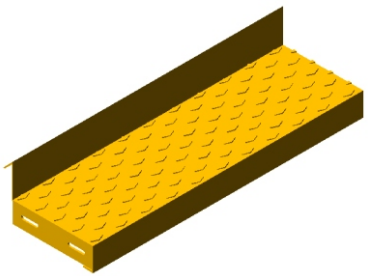
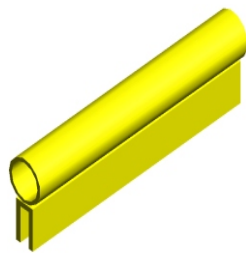
# Dee Zee Britetread Running Board Installation Instruction

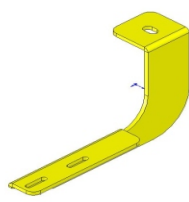
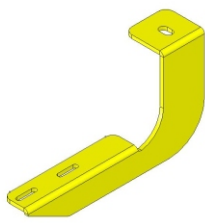
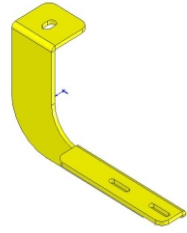
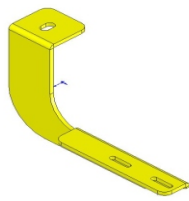
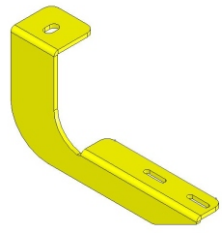
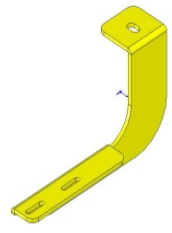
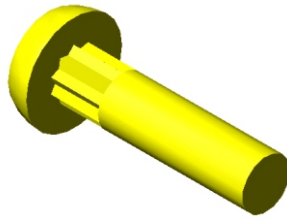
## DZ 1052

### (1999 - Current) Chevy Extended Cab Pickup

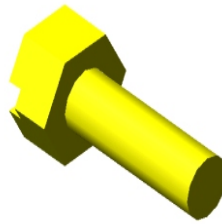
|   |  |  |   |
|---|--|--|---|
| <p><b>A</b> Britetread Running Board</p>  <p><b>X2</b></p>   | <p><b>B</b> Bulb Seal Gasket</p>  <p><b>13.5 ft.</b></p>  | <p><b>C</b> Mudflaps</p>  <p><b>X2</b></p>  |   |
| <p><b>E</b> Front Driver Side Body Mount Bracket</p>  <p><b>X1</b></p>                                      | <p><b>F</b> Middle Driver Side Body Mount Bracket</p>  <p>This is the shortest in the kit <b>X1</b></p>   | <p><b>G</b> Rear Driver Side Body Mount Bracket</p>  <p>This is the tallest in the kit <b>X1</b></p> | <p><b>H</b> Front Passenger Side Body Mount Bracket</p>  <p><b>X1</b></p> |
| <p><b>I</b> Middle Passenger Side Body Mount Bracket</p>  <p>This is the shortest in the kit <b>X1</b></p> | <p><b>J</b> Rear Passenger Side Body Mount Bracket</p>  <p>This is the tallest in the kit <b>X1</b></p> | <p><b>K</b> 1/4 x 3/4" Carriage Head Bolt</p>  <p><b>PN 87</b> <b>X12</b></p>                      | <p><b>L</b> 1/4" Flat Washer</p>  <p><b>PN 72</b> <b>X16</b></p>         |
| <p><b>M</b> 1/4" Hex Nut</p>  <p><b>PN 71</b> <b>X16</b></p>   | <p><b>N</b> 1/4 x 1" Sheet Metal Screw</p>  <p><b>PN 97</b> <b>X4</b></p>                               | <p><b>O</b> 1/4 x 3/4" Hex Head Bolt</p>  <p><b>PN 70</b> <b>X4</b></p>                            |   |

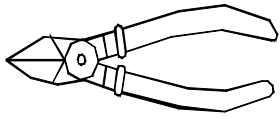
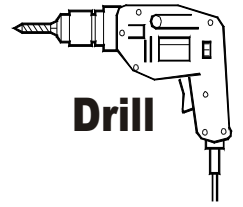
**Tools Required:****Ratchet / Wrench**

**Sizes:**  
**18mm**  
**7/16"**  
**3/8"**

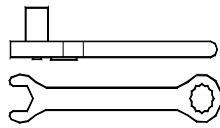

**Tape Measure**

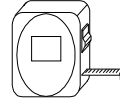

**3/16" Drillbit**  
**1/4" Drillbit**

**1**

Secure britetread mudflap (C) to britetread running board (A) using 1/4 x 3/4" hex head bolts (O), 1/4" flat washers (L), and 1/4" hex nuts (M). Tighten into place using a 7/16" wrench / or socket. Place bulb-seal gasket (B) onto the backlip of britetread running board (A) and trim flush with the britetread mudflap (C) and the end of britetread running board (A).

Fixez le mudflap de britetread (c) au panneau courant de britetread (a) à l'aide des boulons de tête de sortilège de 1/4 x de 3/4"(o), des rondelles plates de 1/4" (l), et des écrous 1/4"de sortilège (m). Serrez dans l'endroit à l'aide d'une clé de 7/16"/ou de la douille. Placez la garniture d'ampoule-joint (b) sur le backlip du panneau courant de britetread (a) et équilibrez à affleurement du mudflap de britetread (c) et de l'extrémité du panneau courant de britetread (a).

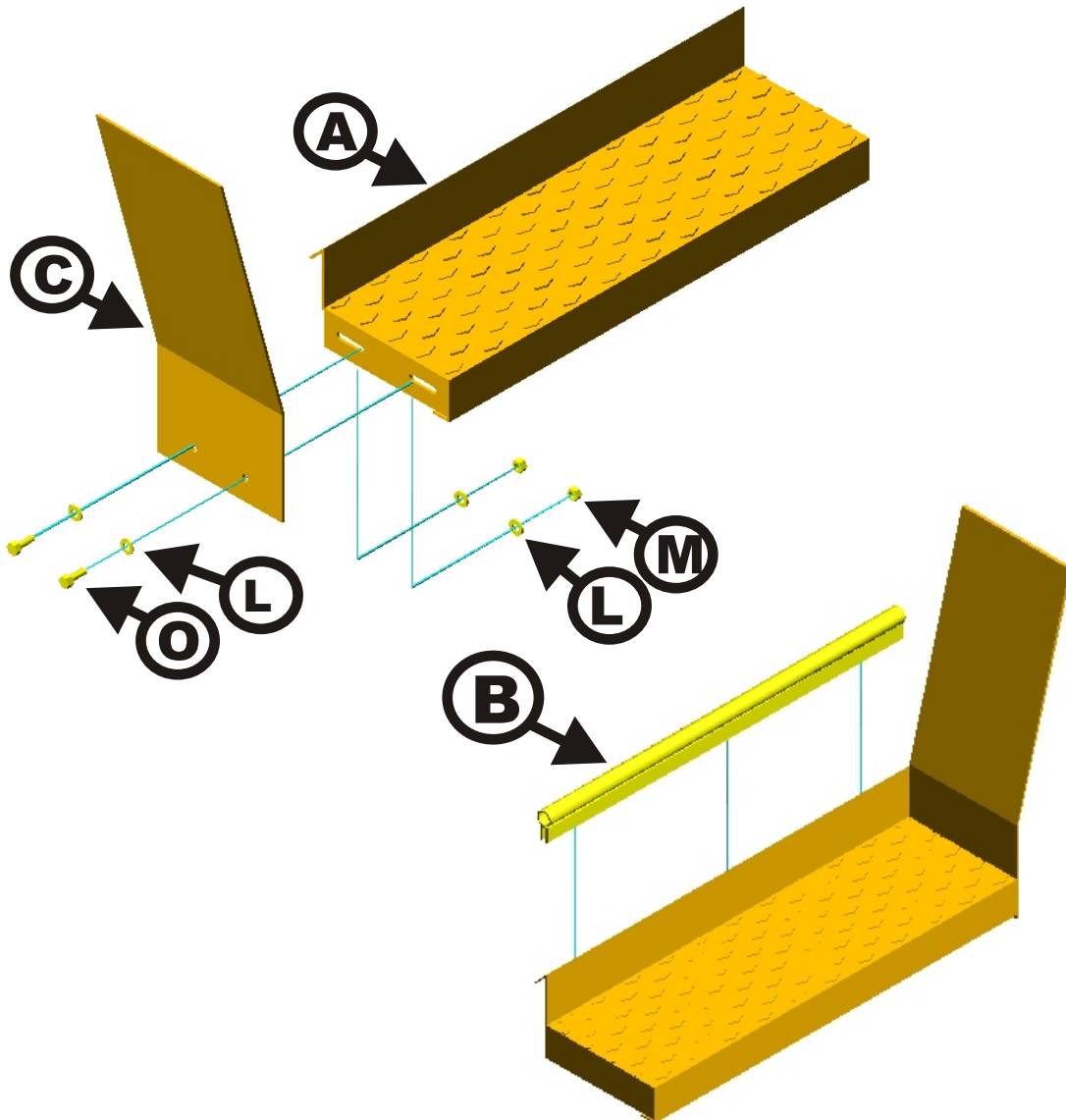

**Britetread  
 Running Board**

**7/16" Wrench  
 or Socket**

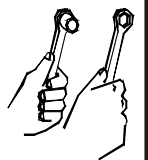

**2**

Locate and remove the front / rear body mount bolts shown below using an 18mm socket/ratchet. Do not discard the body mount bolt or rubber bushing. They will be used in the next step of this installation.

Plac et enlevez boulons avant/arrière de bâti de corps montrés au-dessous d'employer un 18mm socket/ratchet. Ne jetez pas la douille de boulon ou en caoutchouc de bâti de corps. Ils seront employés dans la prochaine étape de cette installation.

**18mm Wrench  
or Socket**

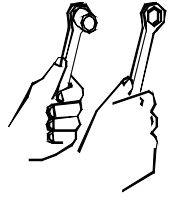

**Front Body Mount**



**Middle Body Mount**



**Rear Body Mount**

**3**

Front / Rear

Place the body mount bolt through the hole in the front body mount bracket and the rubber bushing. Place this assembly up to the body mount locations and tighten into place. See below.

18mm Wrench  
or Socket

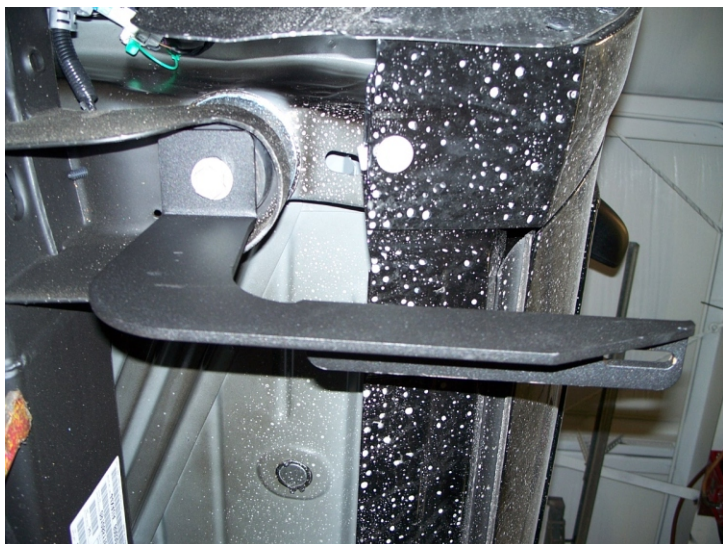
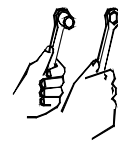

**Front Body Mount**



**Middle Body Mount**  
(Looking towards the front of the truck)



**Rear Body Mount**  
(Looking towards the front of the truck)



**4**

Place the running board up to the front / rear body mount brackets. Make any final adjustments to the alignment of the running board on the vehicle and then use the existing slots in the body mount brackets to drill 1/4" holes through the running board. Secure into place using 1/4 x 1" ribneck carriage head bolts (J), 1/4" flat washers (K), and 1/4" flat washers (L). Tighten into place using a 7/16" wrench / or socket. Note: It is important that all adjustments to the running board and side box board alignment are made prior to drilling any holes in the board.

7/16" Wrench  
or Socket

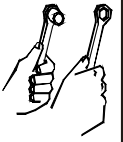

Placez le conseil courant jusqu'à parenthèses avant/arrière de bâti de corps. Faites tous les ajustements finals à l'alignement du conseil courant sur le véhicule et puis employez les fentes existantes dans les parenthèses de bâti de corps pour forer des trous de 1/4" par le conseil courant. Fixez dans l'endroit en utilisant les boulons de tête de chariot de ribneck de 1/4 x de 1"(j), les rondelles plates de 1/4" (k), et les rondelles plates de 1/4"(l). Serrez dans l'endroit à l'aide d'une clé de 7/16"/ou de la douille.

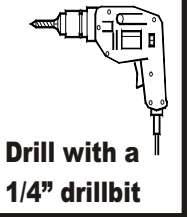

Drill with a  
1/4" drillbit

## Bracket to Board Mount

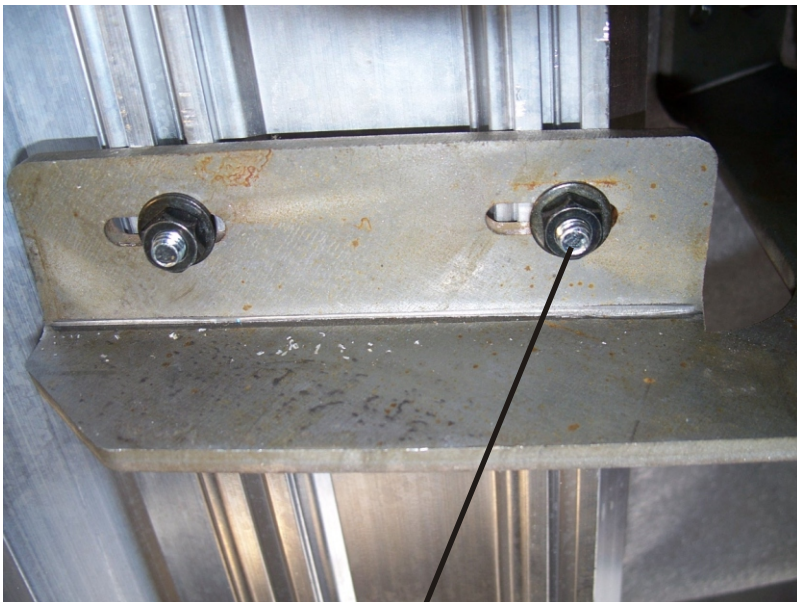

**K L M**

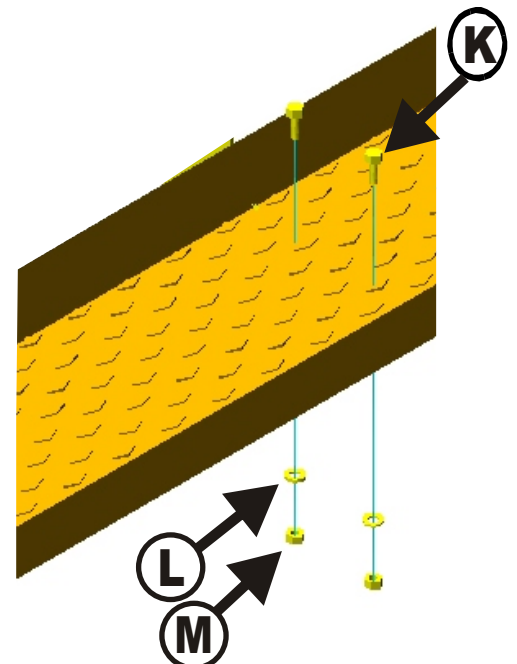
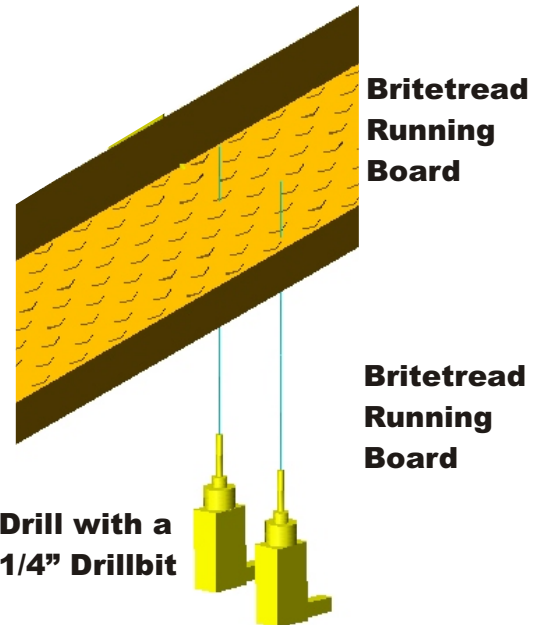

**5**

**Drill two holes through the britetread mudflap and the sheet metal of the vehicle wheel well opening. Secure the britetread mudflap to the vehicle wheel well opening using 1/4 x 1" sheet metal screws (N). Tighten into place using a 3/8" wrench / or socket.**

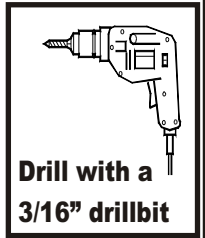

**Forez deux trous par le mudflap de britetread et le métal de feuille de l'ouverture de soute de train de véhicule. Fixez le mudflap de britetread à l'ouverture de soute de train de véhicule à l'aide des vis en métal de feuille de 1/4 x de 1"(mj). Serrez dans l'endroit à l'aide d'une clé de 3/8"/ou du plot.**

