



1-800-779-2102

Mon – Thurs: 8:00am - 5:00pm | Friday: 8:00am - 4:00pm CST

**INSPECT YOUR PRODUCT FOR DAMAGE & MISSING
PARTS BEFORE PROCEEDING TO INSTALLATION**

PROCEDURE FOR RETURNS OR MISSING HARDWARE

-PLEASE CONTACT THE ORIGINAL POINT OF PURCHASE FOR:
SHIPPING DAMAGE, RETURNS, OR WARRANTY CLAIMS

-CONTACT DEE ZEE DIRECTLY FOR MISSING PARTS OR HARDWARE

WWW.DEEZEE.COM

REGISTER YOUR PRODUCT ONLINE: www.deezee.com/registration

VIEW INSTRUCTIONS ONLINE: www.deezee.com/instructions

⚠ WARNING: Cancer and Reproductive Harm
www.P65Warnings.ca.gov

Operating, servicing, and maintaining a passenger vehicle can expose you to chemicals such as lead, phthalates, engine exhaust, and carbon monoxide that are known to the State of California cause cancer and birth defects or other reproductive harm. To minimize exposure, service your vehicle and its accessories in a well-vented area and wear gloves or wash your hands frequently.



DEE ZEE, INC. WARRANTY AGREEMENT

Dee Zee, Inc. guarantees the original purchaser a limited lifetime warranty against manufacturer defects in materials, workmanship, and design under normal use, excluding damage resulting from road hazards such as gravel or other debris, product misuse, improper installation, impairments from accidents, product modifications, improper repairs, spills, vandalism, product neglect, or acts of God.

This warranty applies only to the original purchaser of new product(s) and is limited to the replacement of genuine Dee Zee products. Modification of any kind to Dee Zee products voids all warranty coverage. Warranty does not include electrical components, installation, cost of removal, labor, transportation costs, loss of use, inconvenience, or consequential damages.

WARRANTY COVERAGE - MATERIALS & WORKMANSHIP

LIMITED LIFETIME WARRANTY:

- STAINLESS STEEL: Side Steps, Grill Guards, Bull Bars, Bed Caps, and Side Rails
- ALUMINUM: Side Steps, Running Boards, Storage Boxes, Transfer Tanks, Bed Protection, Side Rails, Invis-A-Racks, and Cab Racks
- PLASTIC: Storage Boxes
- OTHER: Front and Rear Bumpers

THREE-YEAR WARRANTY:

- POWDER-COATED / E-COATED STEEL: Side Steps, Running Boards, Storage Boxes, Transfer Tanks, Cab Racks, Sport Bar Ladder Racks, Cargo Carriers, Mounting Brackets (NX, Rough Step, and Bumper Guards only)
- OTHER: Tailgate Assist, Bed Mats, Floor Mats, Auxiliary Fuel Connection Kits, and All Products Not Otherwise Listed Individually

WARRANTY COVERAGE – FINISH PROTECTION

The finish of all Dee Zee products is covered for one-year (1) from the date of purchase. Dee Zee products have a high quality finish that must be cared for and maintained like any other exposed finish on the vehicle. Protect the finish with non-abrasive automotive wax (e.g. Pure Carnauba) on a regular basis. Applying soaps, polishes, or waxes that contain an abrasive compound may scratch the finish and leave the exposed material susceptible to corrosion.

WARRANTY COVERAGE – COMPONENT PARTS

Operational items such as shocks, latches, hinges, and wear items including, but not limited to, mud flaps, step pads, toolbox tray, end caps, hardware, seals, etc. have a one-year (1) warranty. Replacement component parts can be ordered via credit card (MasterCard or VISA) by calling 1-800-779-2102. All replacement parts are non-returnable and non-refundable.

GPI® FUEL PUMPS & ACCESSORIES

All Great Plains Industries (GPI) products, including transfer tank pumps and fuel meters are covered by GPI's warranty policies. Dee Zee's warranty terms do not apply to GPI products. To submit a warranty claim, please contact GPI at 1-800-835-0113 or visit www.gpi.net.

WARRANTY SUBMISSION PROCEDURE

All warranty claims will be initiated at the place of purchase. The original purchaser will be required to present the original sales receipt with purchase date shown and provide photographs of the defect.

In the event the originally purchased product style is no longer available, Dee Zee will warranty the defective part with a current equivalent. If a comparable product is no longer available, the product would be returned to the store of purchase for a refund or the applicable cost difference can be paid to choose an alternate style.

DISCLAIMER

All products are sold as appearance accessories and should not be relied upon as protection for the vehicle or its occupants in the event of an accident. Vehicles equipped with a supplemental restraints system (air bags) deployed by impact and collision avoidance systems should not be modified in any way. Always consult the vehicle manufacturer if you have any questions regarding supplemental restraint systems and sensors.

Buyer must accommodate front and rear sensors during product installation and assumes all risk should these be tampered, rerouted, severed, or disconnected. This includes disabling visual, audio, or vibration alerts into the cab. Buyer assumes all risk and responsibility for wiring any supplemental auxiliary lights.

Buyer assumes all risk, liability, and cost for the installation and use of Dee Zee products. Dee Zee, Inc. assumes no liability for injury, loss, incidental or consequential damages in the event of an accident.



Thank you for choosing Dee Zee to add function and accessorize your vehicle. Dee Zee has been a staple brand in the truck accessory market since 1977 and we hold a reputation of quality manufacturing based in America's Heartland. Our products are born through careful engineering and backed by industry leading warranty programs. We appreciate the opportunity to serve you and your vehicle!

Review the instruction pages in their entirety to prepare the required tools

Warning: Please check for wiring or other obstructions before drilling any holes in the vehicle. If it is necessary to drill any holes, Dee Zee recommends putting a sealant or rust inhibitory around all holes drilled into the body of the vehicle.

It is the sole responsibility of the vehicle owner to check for tire clearance. It is unlawful and dangerous to ride on any external vehicle step while the vehicle is in motion.

Cleaning: To be entitled to all warranty rights offered with the product, Dee Zee steps need to be cleaned regularly with a mild detergent. Do NOT use abrasive cleaners. For stainless steel products, the application of a high grade automotive wax is recommended.











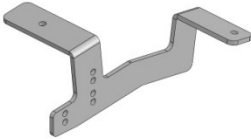
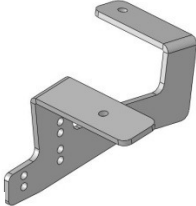

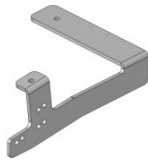
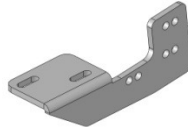
Dee Zee Cares - Please Recycle

For an electronic version of these instructions visit: www.deezee.com/instructions

Register your product online: www.deezee.com/registration

DZ 16212 CHEVROLET EQUINOX/GMC TERRAIN BRACKET KIT

<p>A DZ 16201 / DZ 16202 / DZ 16203 *SOLD SEPARATELY FROM THIS KIT*</p>  <p>BD BRBOARDBB BD BRBOARDBVM BD BRBOARDSSB X2</p>	<p>B RUNNING BOARD BRACKET</p>  <p>B 1814LP X1</p>	<p>C RUNNING BOARD BRACKET</p>  <p>B 1814RP X1</p>
<p>D RUNNING BOARD BRACKET</p>  <p>B 1815LP X1</p>	<p>E RUNNING BOARD BRACKET</p>  <p>B 1815RP X1</p>	<p>F RUNNING BOARD BRACKET</p>  <p>B 1816P X4</p>
<p>G 3/8"-16 X 1.25 HEX CAP SCREW 18-8 SS</p>  <p>PN 440 X2</p>	<p>H M8 X 18 mm SQUARE HEAD BOLT</p>  <p>PN 524 X8</p>	<p>I 3/8-16 LARGE THREAD PLATE</p>  <p>PN 407 X2</p>
<p>J M8 – 1.25 SINGLE TAB WELD NUT</p>  <p>PN 714 X2</p>	<p>K M8 X 25mm HEX HEAD FLANGE BOLT</p>  <p>PN 525 X8</p>	<p>L M8 HEX HEAD FLANGE NUT</p>  <p>PN 526 X20</p>
<p>M M8 – 1.25 DOUBLE TAB WELD NIIT</p>  <p>PN 611 X4</p>	<p>N M8 X 20mm HEX HEAD FLANGE BOLT</p>  <p>PN 527 X12</p>	

Tools Required:



Tape Measure

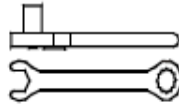

Ratchet / Wrench

13mm

9/16"

Note: Air tools recommended.

1

Place the 8mm square head bolts (H) into the two bolt channels of the running board (A) and slide toward either end of the board. For this application, there should be two bolts in the front channel on opposite ends of the board, and two bolts in the rear channel on opposite ends of the board.

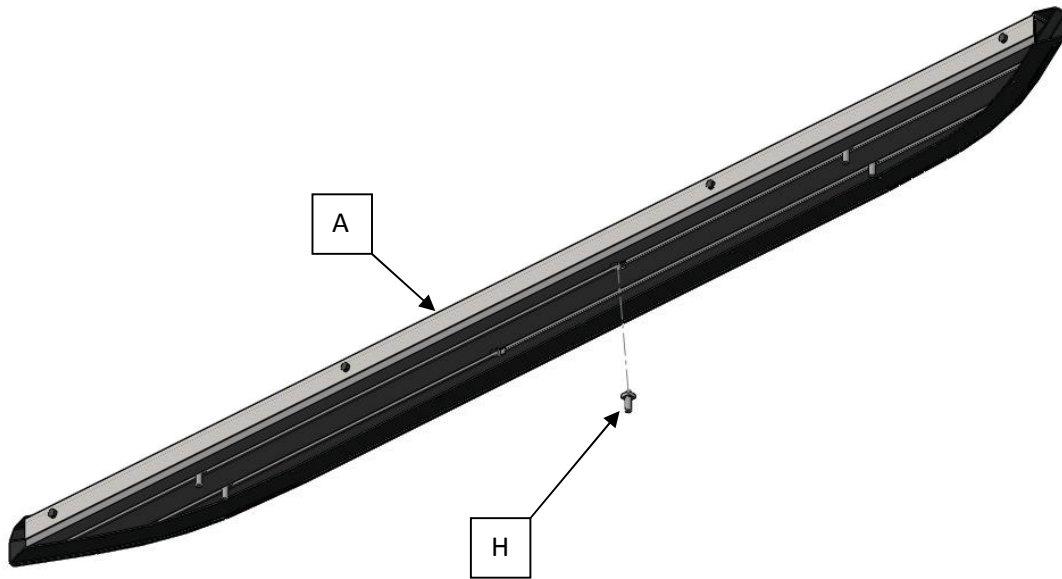

2 Determine the correct bracket alignment per application (To be used in Step 6).

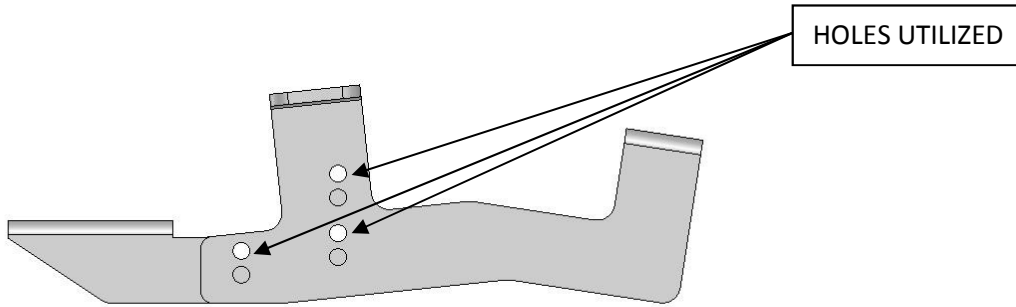

Front Bracket Equinox – driver

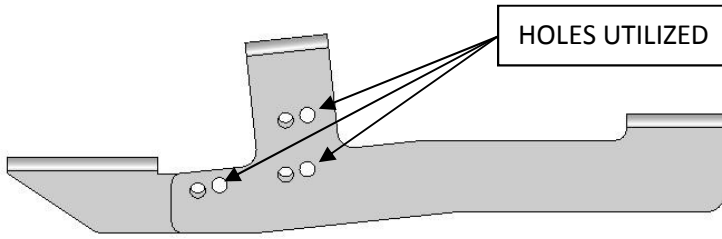

Rear Bracket Equinox – driver

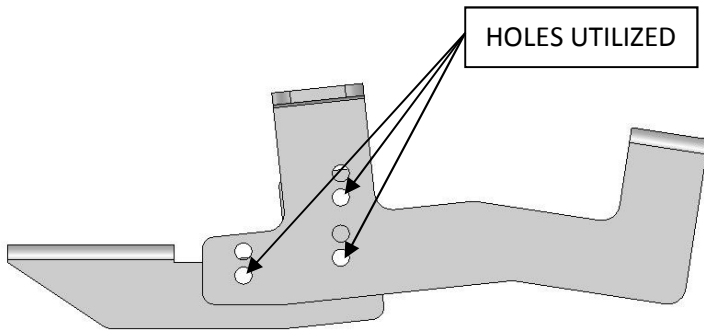

Front Bracket Terrain – driver

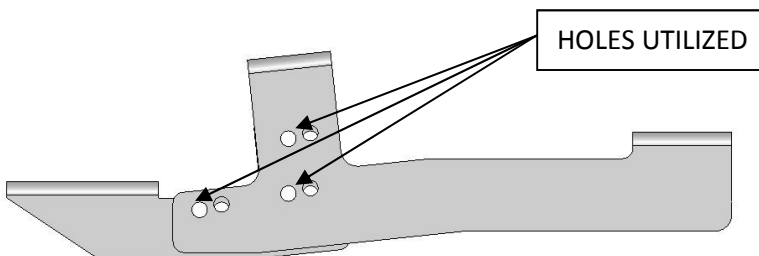

Rear Bracket Terrain – driver

- 3** Locate the existing hole locations shown below. There will be two sets of hole locations (Front, Rear).

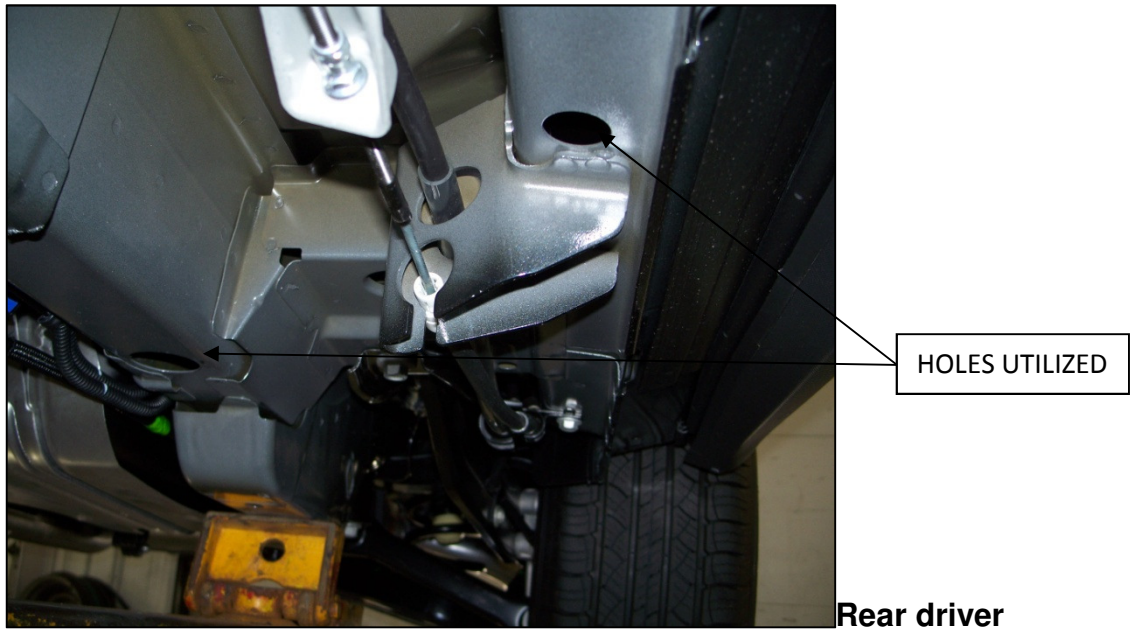
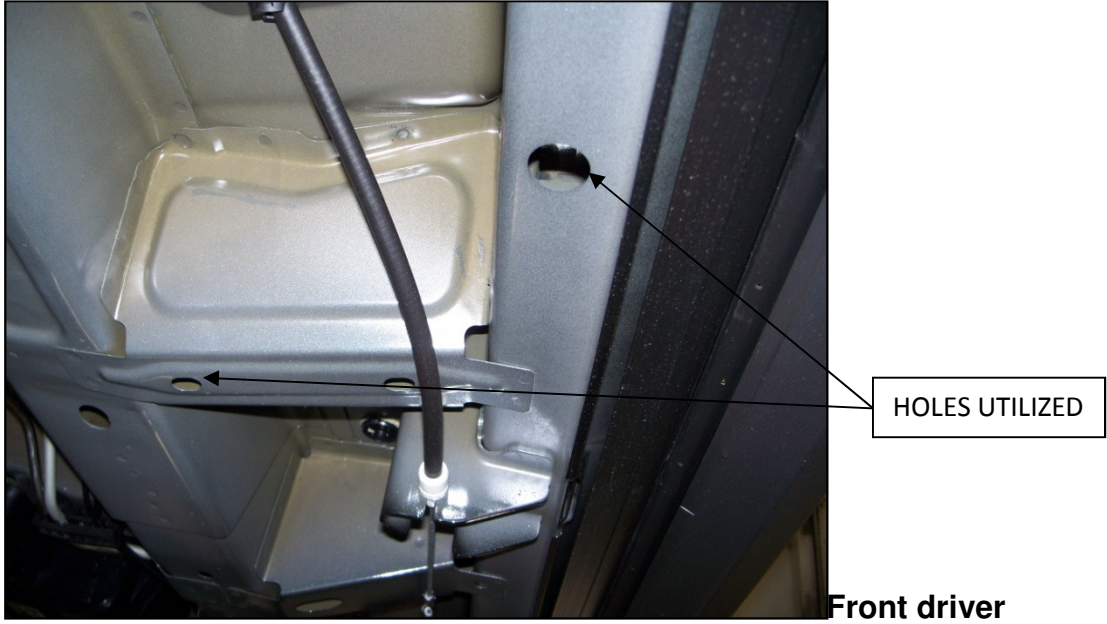

4

Place an 8mm x 25mm hex head bolt (K) through running board bracket (B) and start the bolt into a M8 – 1.25 double tab spot weld nut (M) in the front hole location shown below. Place an 8mm x 25mm hex head bolt (K) through running board bracket (B) and start the bolt into a M8 – 1.25 single tab spot weld nut (J) in the rear hole location shown below. Position bracket into front driver location with thread plates in vehicle openings and tighten completely.

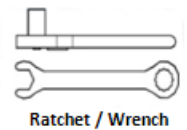
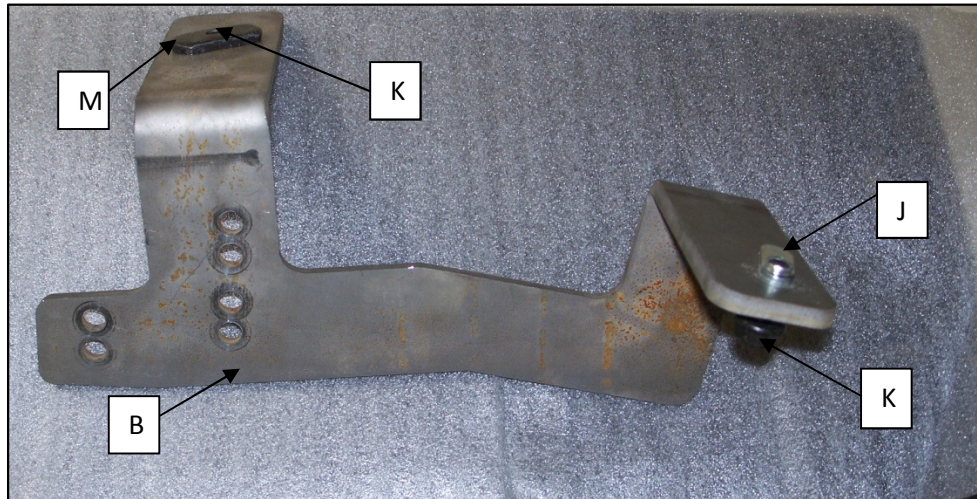

Ratchet / Wrench

13 mm

5

Place an 8mm x 25mm hex head bolt (K) through running board bracket (D) and start the bolt into a M8 – 1.25 double tab spot weld nut (M) in the front hole location shown below. Place a 3/8"-16 x 1.25 hex cap screw (G) through running board bracket (D) and start the bolt into a 3/8"-16 large thread plate (I) in the rear hole location shown below. Position bracket into front driver location with thread plates in vehicle openings and tighten completely.

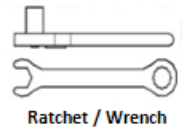
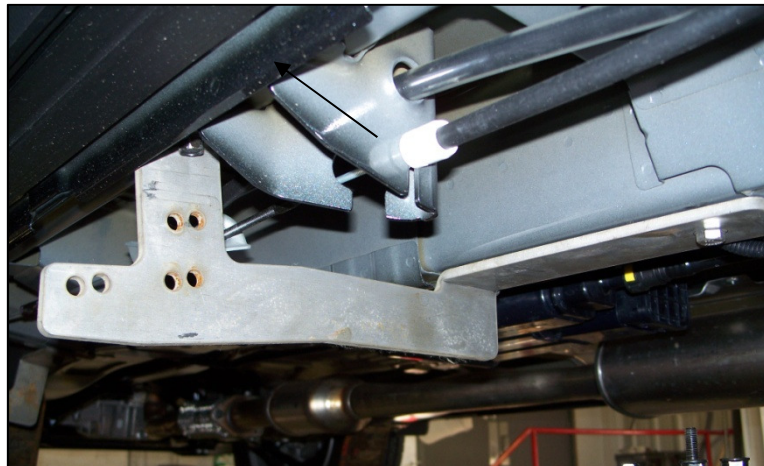
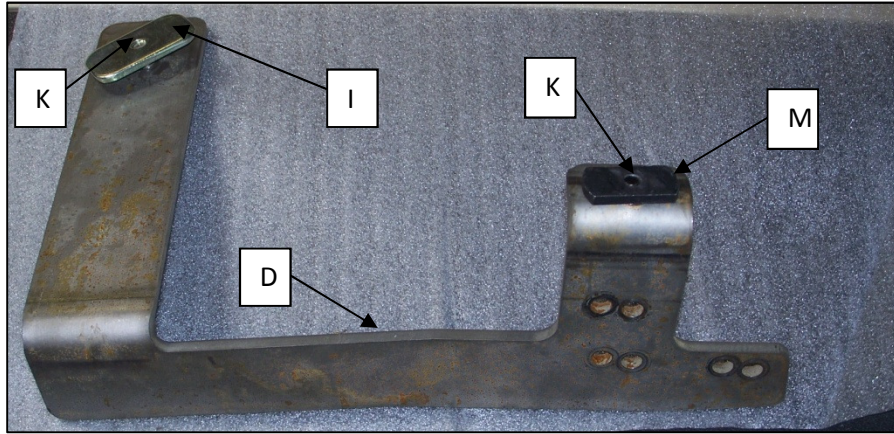

13 mm

9/16"

6

Using the bracket configuration for the application needed (shown in Step 2), place running board bracket (F) onto the correct location in Bracket (B) and bolt together using a 8mmx20mm hex head flange bolt (N) and a M8 flange nut (L). Repeat for the rear bracket location (brackets D and F), again using the correct location from Step 2. Place running board on bracket (F) and start M8 flange nuts (L) onto each of the 8mm square head bolts (H). Do not completely tighten. Rotate board upwards and then place the remaining two 8mmx20mm hex head flange bolt (N) and the two M8 flange nut (L) (per bracket location) and tighten all completely.

Center board on vehicle between wheel well openings or until desired appearance is aquired. Adjust board in/out on vehicle until desired appearance is met. (Note: opening door may aid in determining step surface location in/out on vehicle) Tighten the M8 nuts (L) completely securing the board to the brackets.

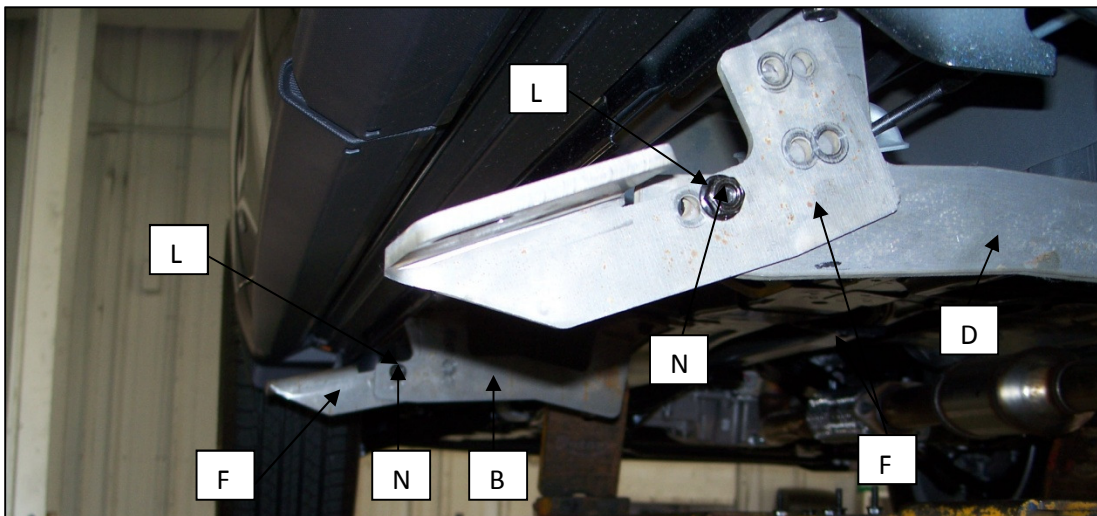

Tape Measure



Ratchet / Wrench

13 mm

7

Repeat steps 1-6 for passenger side using brackets (C) and (E).