



**1-800-779-2102**

Mon – Thurs: 8:00am - 5:00pm | Friday: 8:00am - 4:00pm CST

**INSPECT YOUR PRODUCT FOR DAMAGE & MISSING  
PARTS BEFORE PROCEEDING TO INSTALLATION**

**PROCEDURE FOR RETURNS OR MISSING HARDWARE**

-PLEASE CONTACT THE ORIGINAL POINT OF PURCHASE FOR:  
SHIPPING DAMAGE, RETURNS, OR WARRANTY CLAIMS

-CONTACT DEE ZEE DIRECTLY FOR MISSING PARTS OR HARDWARE

**WWW.DEEZEE.COM**

REGISTER YOUR PRODUCT ONLINE: [www.deezee.com/registration](http://www.deezee.com/registration)

VIEW INSTRUCTIONS ONLINE: [www.deezee.com/instructions](http://www.deezee.com/instructions)

---

**⚠ WARNING:** Cancer and Reproductive Harm  
[www.P65Warnings.ca.gov](http://www.P65Warnings.ca.gov)

Operating, servicing, and maintaining a passenger vehicle can expose you to chemicals such as lead, phthalates, engine exhaust, and carbon monoxide that are known to the State of California cause cancer and birth defects or other reproductive harm. To minimize exposure, service your vehicle and its accessories in a well-vented area and wear gloves or wash your hands frequently.



## DEE ZEE, INC. WARRANTY AGREEMENT

Dee Zee, Inc. guarantees the original purchaser a limited lifetime warranty against manufacturer defects in materials, workmanship, and design under normal use, excluding damage resulting from road hazards such as gravel or other debris, product misuse, improper installation, impairments from accidents, product modifications, improper repairs, spills, vandalism, product neglect, or acts of God.

This warranty applies only to the original purchaser of new product(s) and is limited to the replacement of genuine Dee Zee products. Modification of any kind to Dee Zee products voids all warranty coverage. Warranty does not include electrical components, installation, cost of removal, labor, transportation costs, loss of use, inconvenience, or consequential damages.

### WARRANTY COVERAGE - MATERIALS & WORKMANSHIP

#### LIMITED LIFETIME WARRANTY:

- STAINLESS STEEL: Side Steps, Grill Guards, Bull Bars, Bed Caps, and Side Rails
- ALUMINUM: Side Steps, Running Boards, Storage Boxes, Transfer Tanks, Bed Protection, Side Rails, Invis-A-Racks, and Cab Racks
- PLASTIC: Storage Boxes
- OTHER: Front and Rear Bumpers

#### THREE-YEAR WARRANTY:

- POWDER-COATED / E-COATED STEEL: Side Steps, Running Boards, Storage Boxes, Transfer Tanks, Cab Racks, Sport Bar Ladder Racks, Cargo Carriers, Mounting Brackets (NX, Rough Step, and Bumper Guards only)
- OTHER: Tailgate Assist, Bed Mats, Floor Mats, Auxiliary Fuel Connection Kits, and All Products Not Otherwise Listed Individually

### WARRANTY COVERAGE – FINISH PROTECTION

The finish of all Dee Zee products is covered for one-year (1) from the date of purchase. Dee Zee products have a high quality finish that must be cared for and maintained like any other exposed finish on the vehicle. Protect the finish with non-abrasive automotive wax (e.g. Pure Carnuba) on a regular basis. Applying soaps, polishes, or waxes that contain an abrasive compound may scratch the finish and leave the exposed material susceptible to corrosion.

### WARRANTY COVERAGE – COMPONENT PARTS

Operational items such as shocks, latches, hinges, and wear items including, but not limited to, mud flaps, step pads, toolbox tray, end caps, hardware, seals, etc. have a one-year (1) warranty. Replacement component parts can be ordered via credit card (MasterCard or VISA) by calling 1-800-779-2102. All replacement parts are non-returnable and non-refundable.

## **GPI® FUEL PUMPS & ACCESSORIES**

All Great Plains Industries (GPI) products, including transfer tank pumps and fuel meters are covered by GPI's warranty policies. Dee Zee's warranty terms do not apply to GPI products. To submit a warranty claim, please contact GPI at 1-800-835-0113 or visit [www.gpi.net](http://www.gpi.net).

### **WARRANTY SUBMISSION PROCEDURE**

All warranty claims will be initiated at the place of purchase. The original purchaser will be required to present the original sales receipt with purchase date shown and provide photographs of the defect.

In the event the originally purchased product style is no longer available, Dee Zee will warranty the defective part with a current equivalent. If a comparable product is no longer available, the product would be returned to the store of purchase for a refund or the applicable cost difference can be paid to choose an alternate style.

### **DISCLAIMER**

All products are sold as appearance accessories and should not be relied upon as protection for the vehicle or its occupants in the event of an accident. Vehicles equipped with a supplemental restraints system (air bags) deployed by impact and collision avoidance systems should not be modified in any way. Always consult the vehicle manufacturer if you have any questions regarding supplemental restraint systems and sensors.

Buyer must accommodate front and rear sensors during product installation and assumes all risk should these be tampered, rerouted, severed, or disconnected. This includes disabling visual, audio, or vibration alerts into the cab. Buyer assumes all risk and responsibility for wiring any supplemental auxiliary lights.

Buyer assumes all risk, liability, and cost for the installation and use of Dee Zee products. Dee Zee, Inc. assumes no liability for injury, loss, incidental or consequential damages in the event of an accident.



Thank you for choosing Dee Zee to add function and accessorize your vehicle. Dee Zee has been a staple brand in the truck accessory market since 1977 and we hold a reputation of quality manufacturing based in America's Heartland. Our products are born through careful engineering and backed by industry leading warranty programs. We appreciate the opportunity to serve you and your vehicle!

**Review the instruction pages in their entirety to prepare the required tools**

**Warning:** Please check for wiring or other obstructions before drilling any holes in the vehicle. If it is necessary to drill any holes, Dee Zee recommends putting a sealant or rust inhibitory around all holes drilled into the body of the vehicle.

It is the sole responsibility of the vehicle owner to check for tire clearance. It is unlawful and dangerous to ride on any external vehicle step while the vehicle is in motion.

**Cleaning:** To be entitled to all warranty rights offered with the product, Dee Zee steps need to be cleaned regularly with a mild detergent. Do NOT use abrasive cleaners. For stainless steel products, the application of a high grade automotive wax is recommended.





Dee Zee Cares - Please Recycle

For an electronic version of these instructions visit: [www.deezee.com/instructions](http://www.deezee.com/instructions)

Register your product online: [www.deezee.com/registration](http://www.deezee.com/registration)

# DZ 16275 Installation Instructions

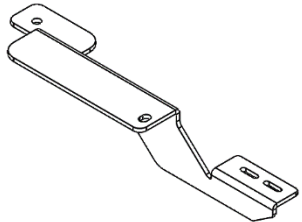
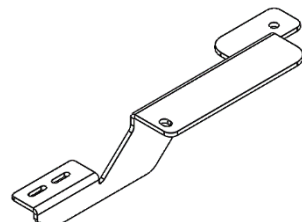
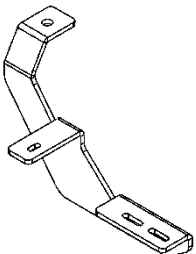
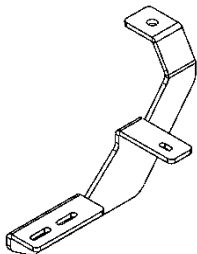
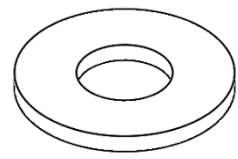
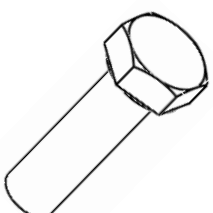
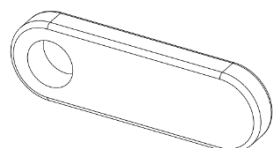
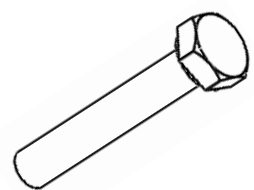
## Kia Telluride 2020-Current

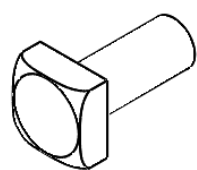
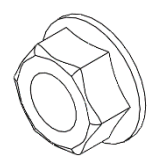
<p><b>A</b> DZ 16201 / DZ 16202 / DZ 16203 *SOLD SEPARATELY FROM THIS KIT*</p>  <p>BD BRBOARDBB BD BRBOARDBVM BD BRBOARDSSB      X2</p>	<p><b>B</b> Driver Front Bracket</p>  <p>B 2804LP      X1</p>	<p><b>C</b> Passenger Front Bracket</p>  <p>B 2804RP      X1</p>
<p><b>D</b> Driver Rear Bracket</p>  <p>B 2805LP      X1</p>	<p><b>E</b> Passenger Rear Bracket</p>  <p>B 2805RP      X1</p>	<p><b>F</b> M10 Flat Washer</p>  <p>PN 113B      X6</p>
<p><b>G</b> M10-1.5 X 35mm Hex Bolt</p>  <p>PN 744B      X6</p>	<p><b>H</b> M10 Thread Plate</p>  <p>PN 742      X6</p>	<p><b>I</b> M6-1 X 35mm Hex Bolt</p>  <p>PN 743      X2</p>
<p><b>J</b> M6 Washer</p>  <p>PN 785B      X4</p>	<p><b>K</b> M8 Square Head Bolt</p>  <p>PN 524      X8</p>	<p><b>L</b> M8-1.25 Hex Nut</p>  <p>PN 526      X8</p>

**Required tools:**

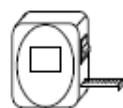

**Tape Measure**

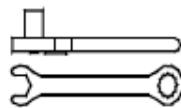

8mm 10mm  
13mm 14mm  
17mm

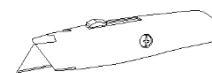

Utility Knife

**1**

Place the 8mm square head bolts (K) into the two bolt channels of the running board (A) and slide toward either end of the board. For this application, there should be two bolts in each channel on opposite ends of the board.

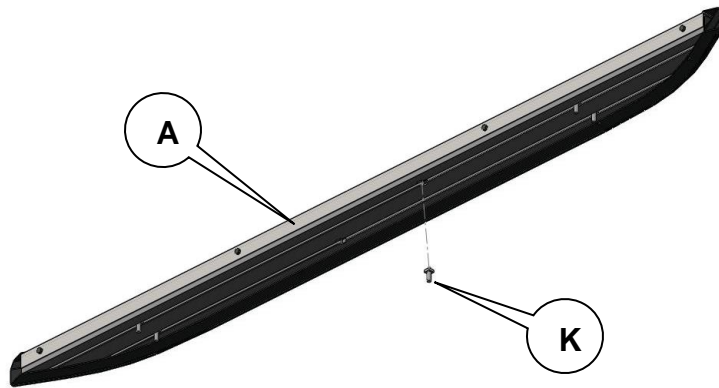

**2**

Remove Felt skid plate, arrows shown below are the bolts that need removed. Passenger side shown below.

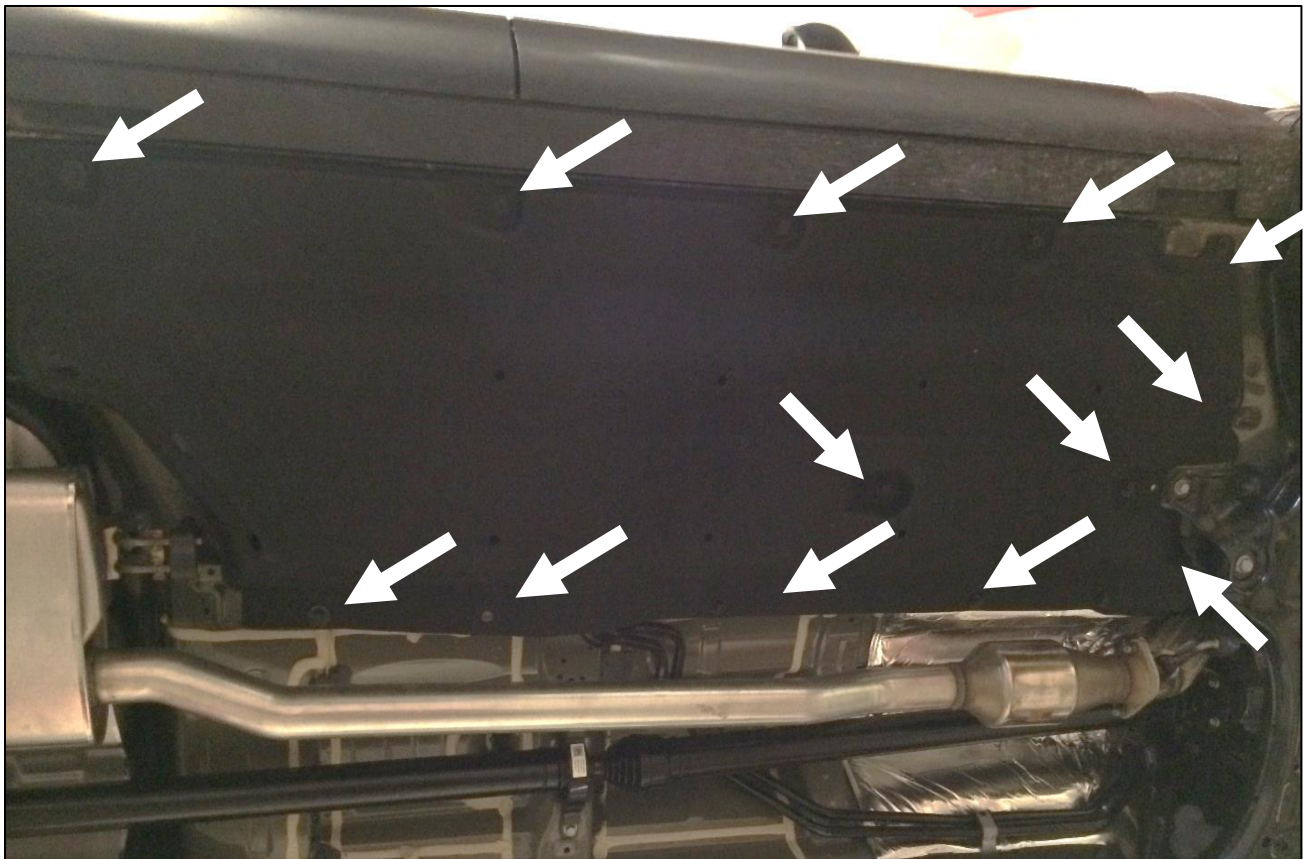

**3**

Locate the Front Driver and Rear Driver locations shown below. In the front location, two rubber plugs will need to be removed. In the rear location, one rubber plug will need to be removed.

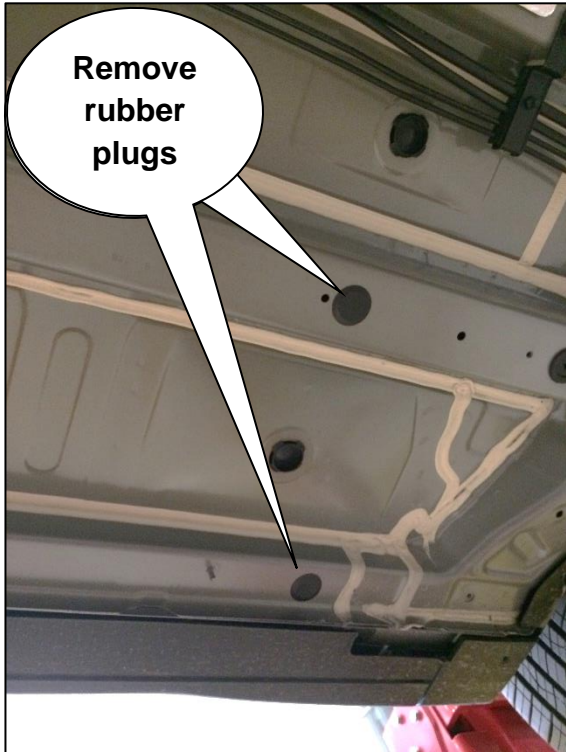

**Front Driver**

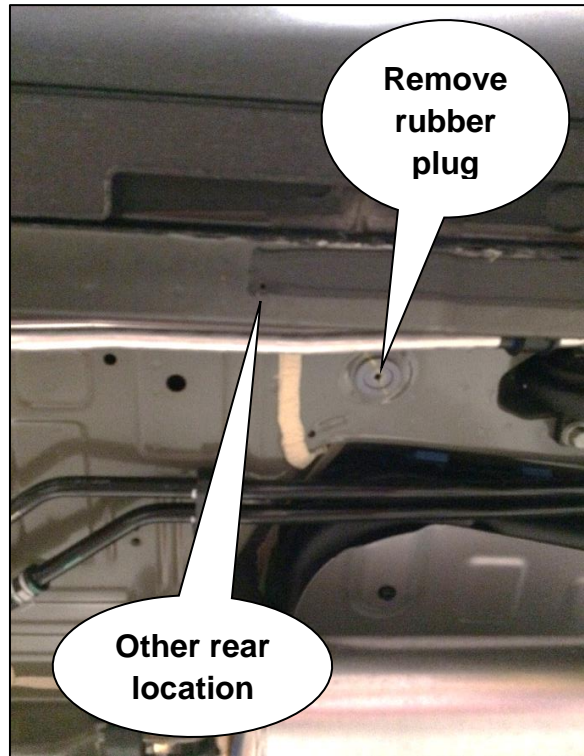

**Rear Driver**

**4** Preassemble driver front bracket (B) and driver rear bracket (D) using bolts (G), washers (F), and thread plates (H).

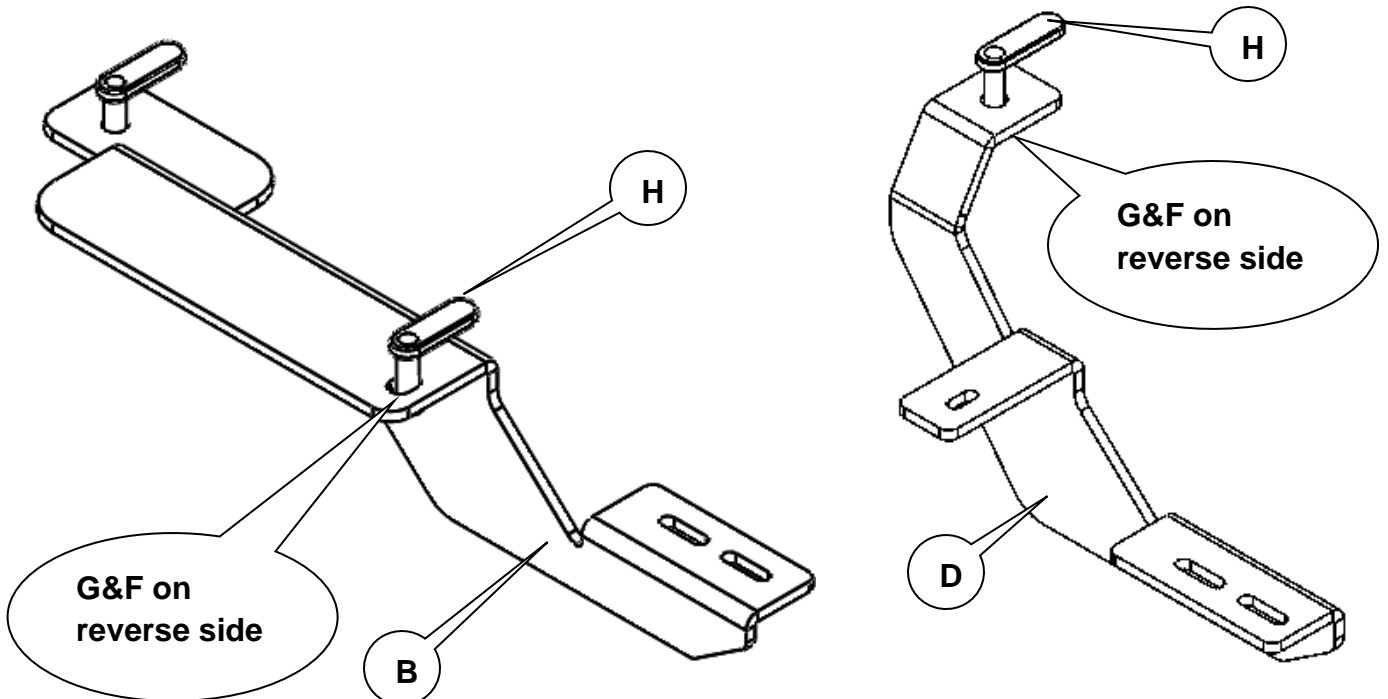

**5**

Install preassembled front bracket by sliding thread plates into the two holes from step three. Do not fully tighten at this time.



**6**

Install preassembled rear bracket by sliding the thread plate into the upper location. Do not fully tighten at this time.





**7**

Install board (A) putting the bolts from the board through the brackets and install nuts (L). Center the board and fully tighten board to brackets.

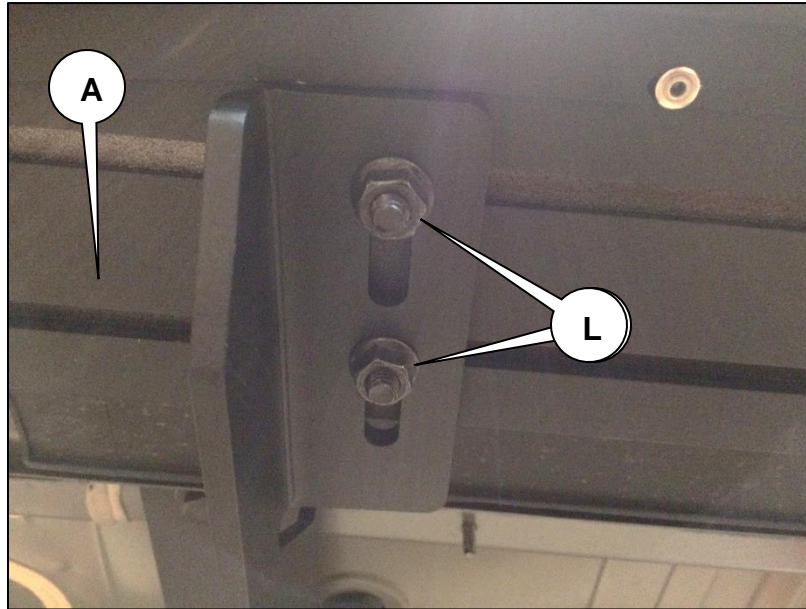

**8**

Trim the felt skid plate as shown below. Remove the last plastic grommet from outer rear of the felt skid plate. Then reinstall felt skid plate on vehicle.

Cut off end  
flush with  
plastic grommet



- 9** Reinstall cut felt skid plate with hardware removed and install bolt (I) and washer (J) through the skid plate, bracket and into the threaded hole. Fully tighten all hardware

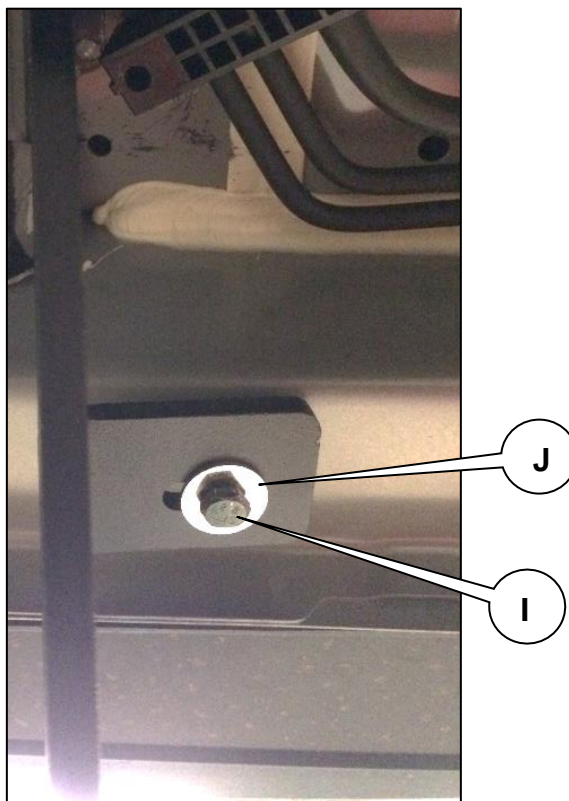

- 10** Repeat steps on passengers side using passenger side braces.

