



1-800-779-2102

Mon – Thurs: 8:00am - 5:00pm | Friday: 8:00am - 4:00pm CST

**INSPECT YOUR PRODUCT FOR DAMAGE & MISSING
PARTS BEFORE PROCEEDING TO INSTALLATION**

PROCEDURE FOR RETURNS OR MISSING HARDWARE

-PLEASE CONTACT THE ORIGINAL POINT OF PURCHASE FOR:
SHIPPING DAMAGE, RETURNS, OR WARRANTY CLAIMS

-CONTACT DEE ZEE DIRECTLY FOR MISSING PARTS OR HARDWARE

WWW.DEEZEE.COM

REGISTER YOUR PRODUCT ONLINE: www.deezee.com/registration

VIEW INSTRUCTIONS ONLINE: www.deezee.com/instructions

⚠️ WARNING: Cancer and Reproductive Harm
www.P65Warnings.ca.gov

Operating, servicing, and maintaining a passenger vehicle can expose you to chemicals such as lead, phthalates, engine exhaust, and carbon monoxide that are known to the State of California cause cancer and birth defects or other reproductive harm. To minimize exposure, service your vehicle and its accessories in a well-vented area and wear gloves or wash your hands frequently.



DEE ZEE, INC. WARRANTY AGREEMENT

Dee Zee, Inc. guarantees the original purchaser a limited lifetime warranty against manufacturer defects in materials, workmanship, and design under normal use, excluding damage resulting from road hazards such as gravel or other debris, product misuse, improper installation, impairments from accidents, product modifications, improper repairs, spills, vandalism, product neglect, or acts of God.

This warranty applies only to the original purchaser of new product(s) and is limited to the replacement of genuine Dee Zee products. Modification of any kind to Dee Zee products voids all warranty coverage. Warranty does not include electrical components, installation, cost of removal, labor, transportation costs, loss of use, inconvenience, or consequential damages.

WARRANTY COVERAGE - MATERIALS & WORKMANSHIP

LIMITED LIFETIME WARRANTY:

- STAINLESS STEEL: Side Steps, Grill Guards, Bull Bars, Bed Caps, and Side Rails
- ALUMINUM: Side Steps, Running Boards, Storage Boxes, Transfer Tanks, Bed Protection, Side Rails, Invis-A-Racks, and Cab Racks
- PLASTIC: Storage Boxes
- OTHER: Front and Rear Bumpers

THREE-YEAR WARRANTY:

- POWDER-COATED / E-COATED STEEL: Side Steps, Running Boards, Storage Boxes, Transfer Tanks, Cab Racks, Sport Bar Ladder Racks, Cargo Carriers, Mounting Brackets (NX, Rough Step, and Bumper Guards only)
- OTHER: Tailgate Assist, Bed Mats, Floor Mats, Auxiliary Fuel Connection Kits, and All Products Not Otherwise Listed Individually

WARRANTY COVERAGE – FINISH PROTECTION

The finish of all Dee Zee products is covered for one-year (1) from the date of purchase. Dee Zee products have a high quality finish that must be cared for and maintained like any other exposed finish on the vehicle. Protect the finish with non-abrasive automotive wax (e.g. Pure Carnauba) on a regular basis. Applying soaps, polishes, or waxes that contain an abrasive compound may scratch the finish and leave the exposed material susceptible to corrosion.

WARRANTY COVERAGE – COMPONENT PARTS

Operational items such as shocks, latches, hinges, and wear items including, but not limited to, mud flaps, step pads, toolbox tray, end caps, hardware, seals, etc. have a one-year (1) warranty. Replacement component parts can be ordered via credit card (MasterCard or VISA) by calling 1-800-779-2102. All replacement parts are non-returnable and non-refundable.

GPI® FUEL PUMPS & ACCESSORIES

All Great Plains Industries (GPI) products, including transfer tank pumps and fuel meters are covered by GPI's warranty policies. Dee Zee's warranty terms do not apply to GPI products. To submit a warranty claim, please contact GPI at 1-800-835-0113 or visit www.gpi.net.

WARRANTY SUBMISSION PROCEDURE

All warranty claims will be initiated at the place of purchase. The original purchaser will be required to present the original sales receipt with purchase date shown and provide photographs of the defect.

In the event the originally purchased product style is no longer available, Dee Zee will warranty the defective part with a current equivalent. If a comparable product is no longer available, the product would be returned to the store of purchase for a refund or the applicable cost difference can be paid to choose an alternate style.

DISCLAIMER

All products are sold as appearance accessories and should not be relied upon as protection for the vehicle or its occupants in the event of an accident. Vehicles equipped with a supplemental restraints system (air bags) deployed by impact and collision avoidance systems should not be modified in any way. Always consult the vehicle manufacturer if you have any questions regarding supplemental restraint systems and sensors.

Buyer must accommodate front and rear sensors during product installation and assumes all risk should these be tampered, rerouted, severed, or disconnected. This includes disabling visual, audio, or vibration alerts into the cab. Buyer assumes all risk and responsibility for wiring any supplemental auxiliary lights.

Buyer assumes all risk, liability, and cost for the installation and use of Dee Zee products. Dee Zee, Inc. assumes no liability for injury, loss, incidental or consequential damages in the event of an accident.



Thank you for choosing Dee Zee to add function and accessorize your vehicle. Dee Zee has been a staple brand in the truck accessory market since 1977 and we hold a reputation of quality manufacturing based in America's Heartland. Our products are born through careful engineering and backed by industry leading warranty programs. We appreciate the opportunity to serve you and your vehicle!

Review the instruction pages in their entirety to prepare the required tools

Warning: Please check for wiring or other obstructions before drilling any holes in the vehicle. If it is necessary to drill any holes, Dee Zee recommends putting a sealant or rust inhibitory around all holes drilled into the body of the vehicle.

It is the sole responsibility of the vehicle owner to check for tire clearance. It is unlawful and dangerous to ride on any external vehicle step while the vehicle is in motion.

Cleaning: To be entitled to all warranty rights offered with the product, Dee Zee steps need to be cleaned regularly with a mild detergent. Do NOT use abrasive cleaners. For stainless steel products, the application of a high grade automotive wax is recommended.



Dee Zee Cares - Please Recycle

For an electronic version of these instructions visit: www.deezee.com/instructions

Register your product online: www.deezee.com/registration

4" OVAL BENT END SIDEBARS
2019 CHEVY SILVERADO/GMC SIERRA 1500 CREW CAB
EXCLUDES BODY LIFT KIT

(W)
INSTALLATION INSTRUCTIONS
4" OVAL BENT END SIDEBARS
2019 CHEVY SILVERADO/GMC SIERRA 1500 CREW CAB
EXCLUDES BODY LIFT KIT
PART # DZ 373537;DZ 373539

PARTS LIST:

1	Driver/left side 4" Oval Bent End Sidebar	1	Passenger/right Rear Mounting Bracket
1	Passenger/right side 4" Oval Bent End Sidebar	4	1/2" x 2" Hex Bolts
1	Driver/left Front Mounting Bracket	4	1/2" Lock Washers
1	Passenger/right Front Mounting Bracket	4	1/2" x 1-1/2" OD x 1/8" Large Flat Washers
2	Center Support Brackets	2	8-1.25mm x 25mm Combo Bolts
1	Driver/left Rear Mounting Bracket		

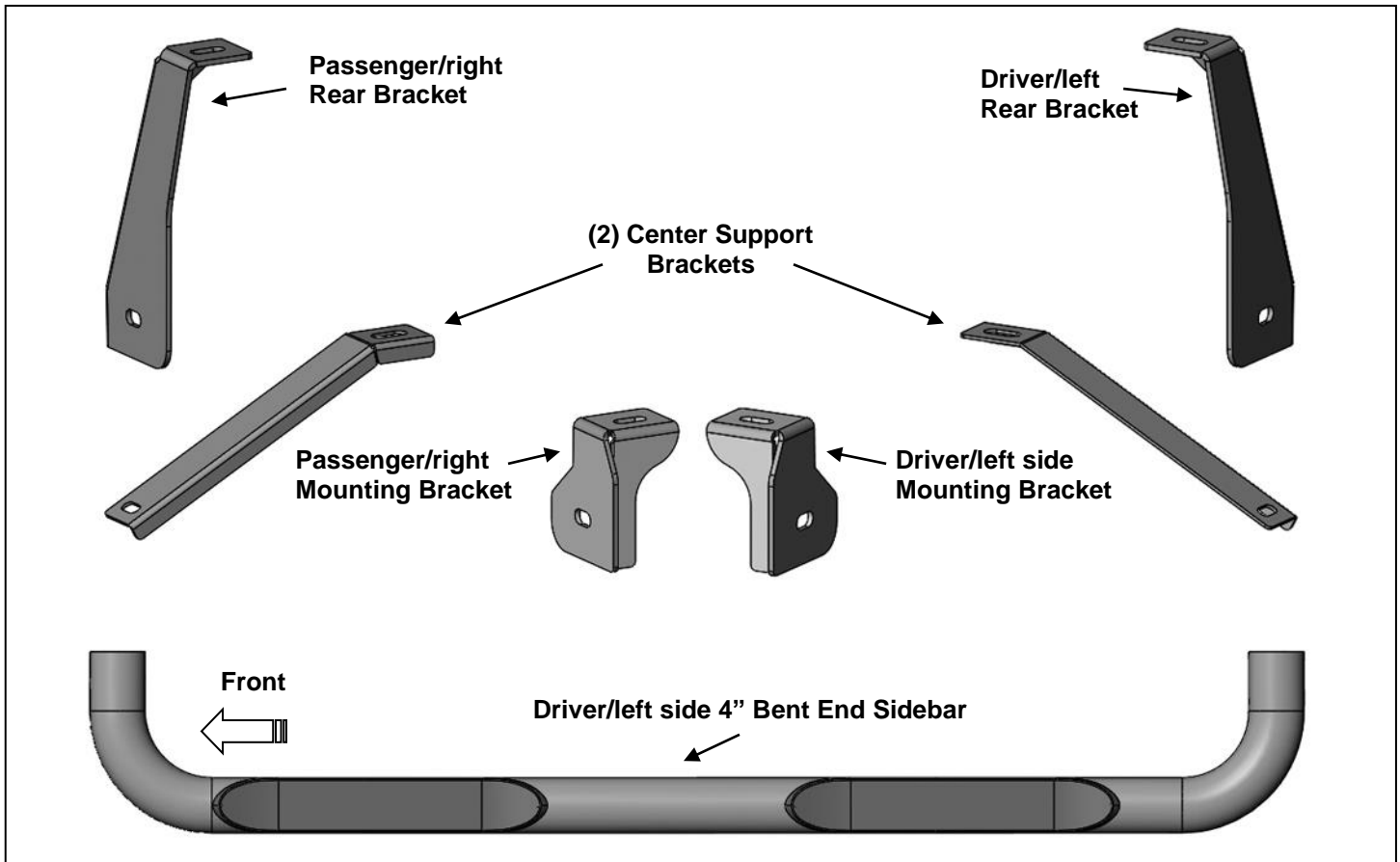

PROCEDURE:

REMOVE CONTENTS FROM BOX. VERIFY ALL PARTS ARE PRESENT. READ INSTRUCTIONS CAREFULLY BEFORE STARTING INSTALLATION. ASSISTANCE IS RECOMMENDED.

1. Start the installation under the driver/left side of the vehicle. Locate the front body mount, **(Figure 1)**. Remove the front body bolt.
2. Select the Driver/left side Front Bracket, **(Figure 2)**. Line up the upper slot on the Bracket with the body bolt hole. Reuse the factory body bolt to attach the Bracket to the top of the body mount, **(Figure 2)**.
3. Move to the center mounting location, **(Figure 3)**. Repeat **Steps 1 & 2** to install (1) Center Support Bracket to the center body mount, **(Figure 4)**.
4. Move to the rear mounting location, **(Figure 5)**. Repeat **Steps 1 & 2** to install the Rear Mounting Bracket to the rear body mount, **(Figure 6)**.
5. Carefully unwrap and select the Driver/left Sidebar. Use the illustration above to help identify the correct Sidebar. With assistance, line up the front end of the tube with the front Bracket slot, **(Figure 7)**. Use (1) 1/2" Hex Bolt, (1) 1/2" Lock Washer and (1) 1/2" Flat Washer to attach

the front end of the Sidebar tube to the Front Bracket, **(Figure 8)**. Snug but do not tighten hardware at this time.

6. Attach the Sidebar to the Center Support Bracket using (1) 8mm Combo Bolt, **(Figures 9 & 10)**. Do not tighten hardware at this time.
7. Repeat **Step 5** to attach the rear end of the Sidebar to the Rear Bracket, **(Figures 11 & 12)**.
8. Level and adjust the Sidebar as necessary and fully tighten all hardware.
9. Repeat **Steps 1—8** for Passenger/right Sidebar installation.
10. Do periodic inspections to the installation to make sure that all hardware is secure and tight.

To protect your investment, wax this product after installing. Regular waxing is recommended to add a protective layer over the finish. Do not use any type of polish or wax that may contain abrasives that could damage the finish. Mild soap may be used also to clean the Sidebar.

Driver/left Side Installation Pictured

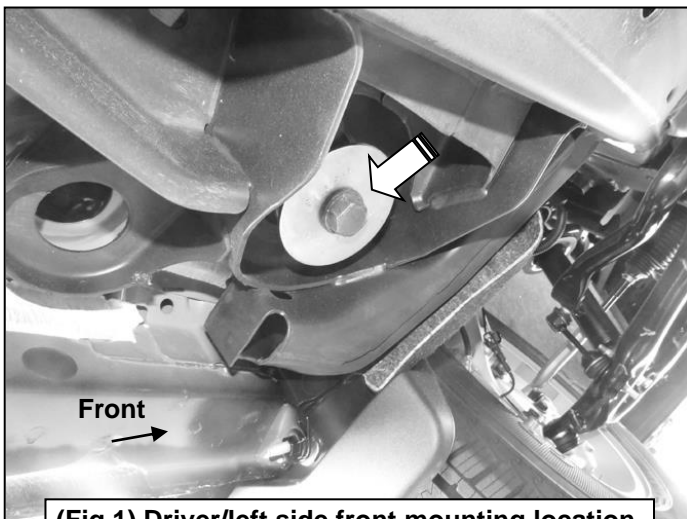

(Fig 1) Driver/left side front mounting location

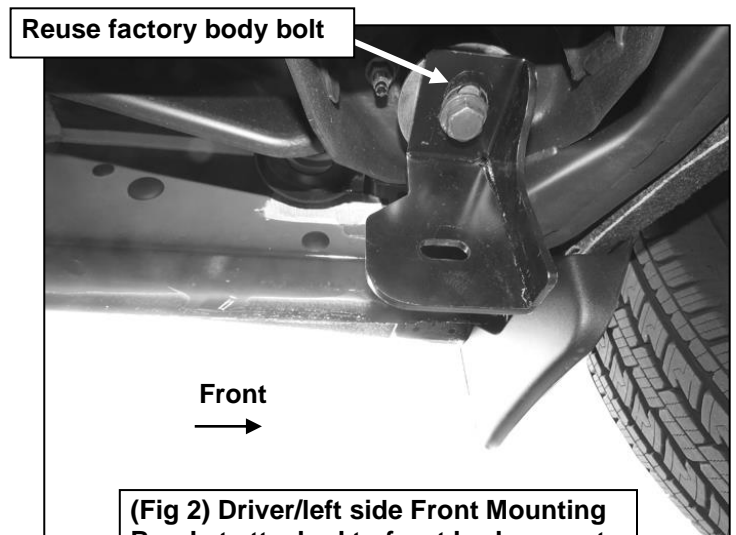

(Fig 2) Driver/left side Front Mounting Bracket attached to front body mount

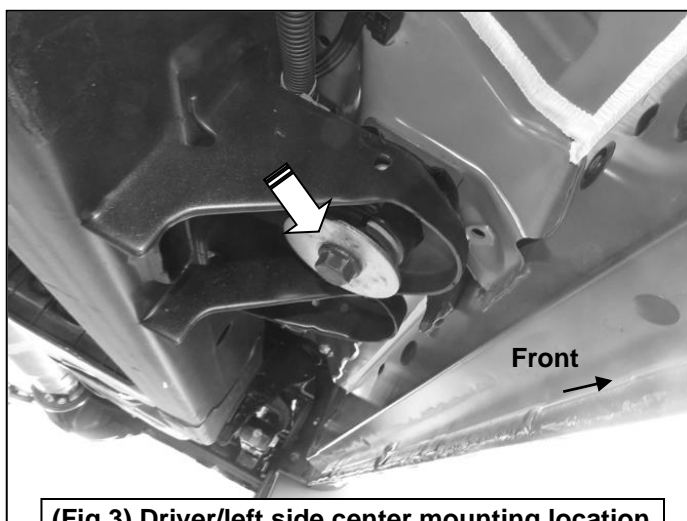

(Fig 3) Driver/left side center mounting location

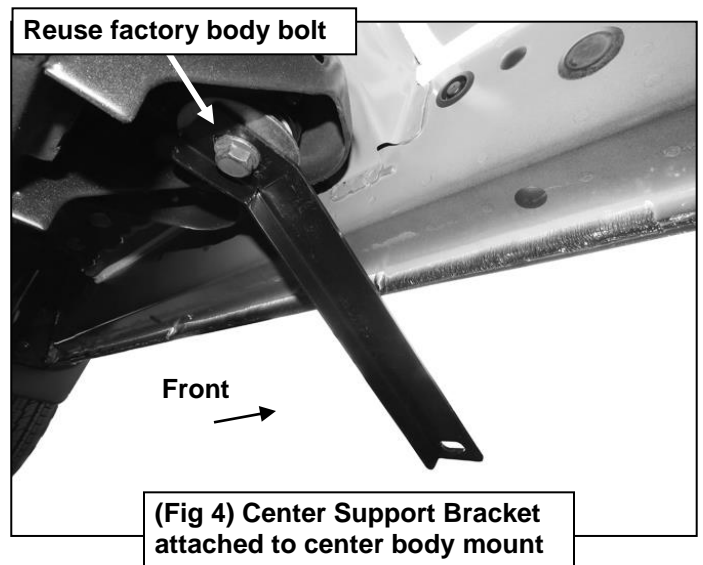

(Fig 4) Center Support Bracket attached to center body mount

Driver/left Side Installation Pictured

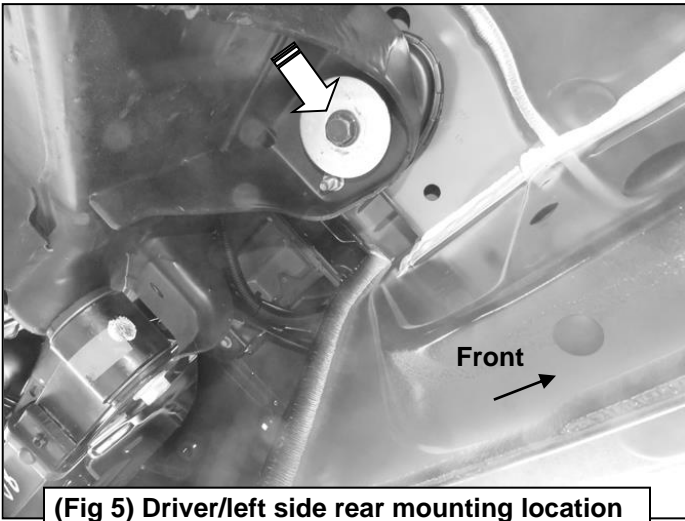

(Fig 5) Driver/left side rear mounting location

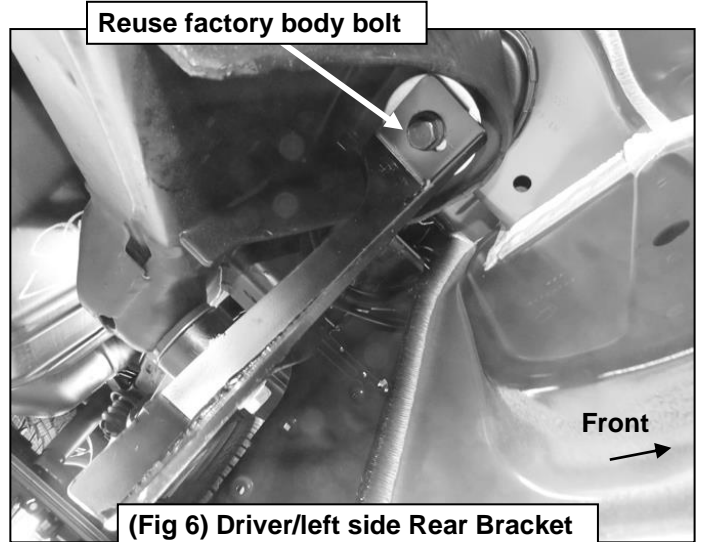

Reuse factory body bolt

(Fig 6) Driver/left side Rear Bracket attached to the rear body mount

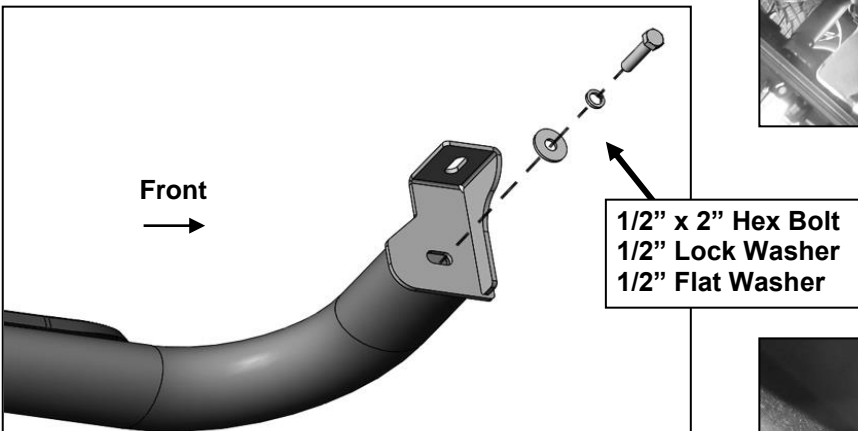

1/2" x 2" Hex Bolt
1/2" Lock Washer
1/2" Flat Washer

(Fig 7) Driver/left front of Sidebar attached to Front Mounting Bracket illustrated

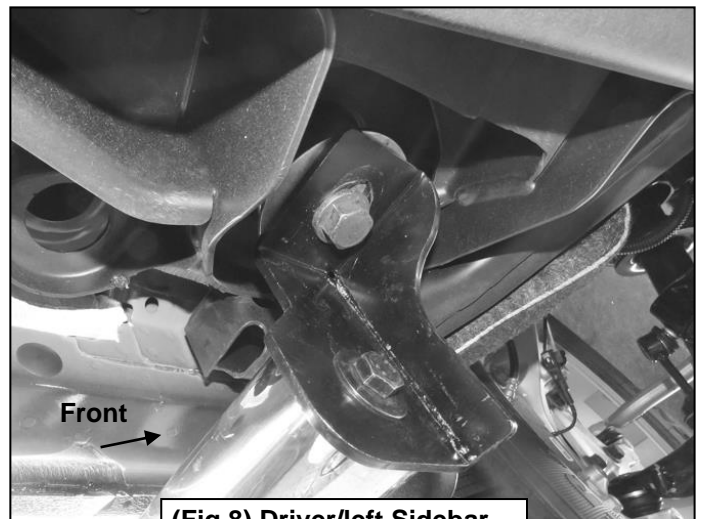

(Fig 8) Driver/left Sidebar attached to Front Bracket

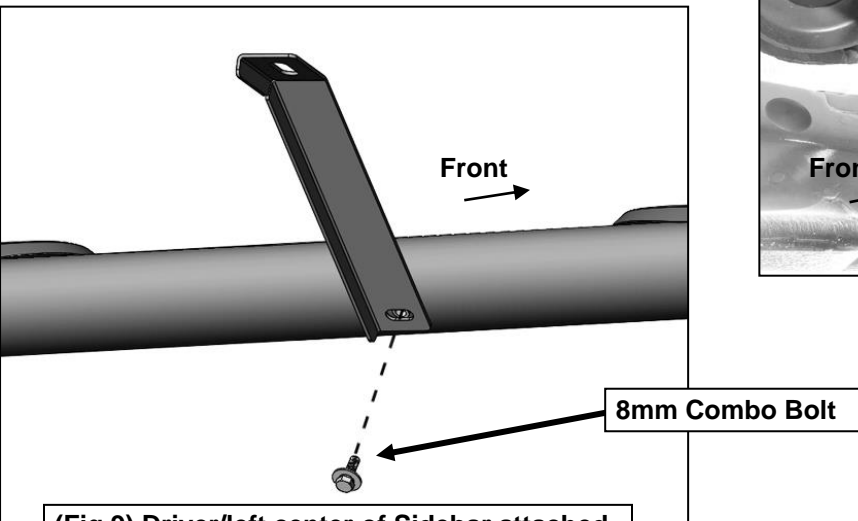

8mm Combo Bolt

(Fig 9) Driver/left center of Sidebar attached to Center Support Bracket illustrated

Driver/left Side Installation Pictured

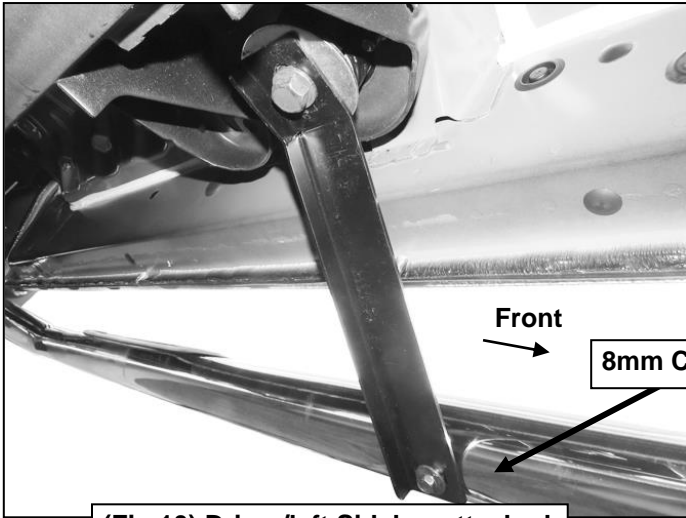

(Fig 10) Driver/left Sidebar attached to Center Support Bracket

8mm Combo Bolt

**1/2" x 2" Hex Bolt
1/2" Lock Washer
1/2" Flat Washer**

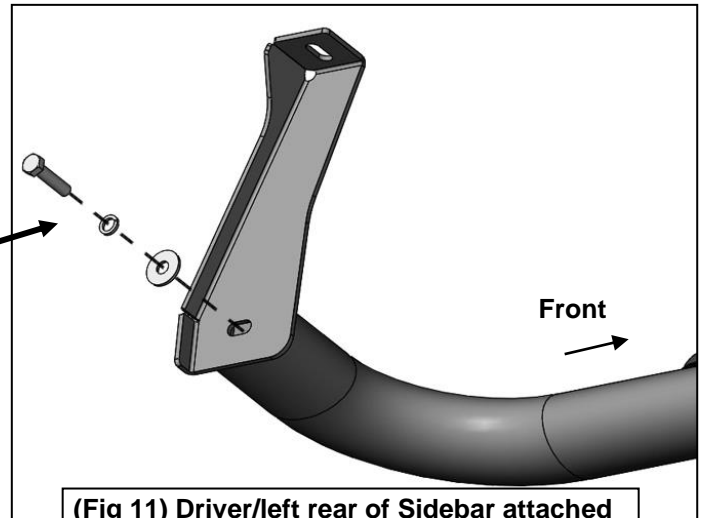

(Fig 11) Driver/left rear of Sidebar attached to the Rear Mounting Bracket illustrated

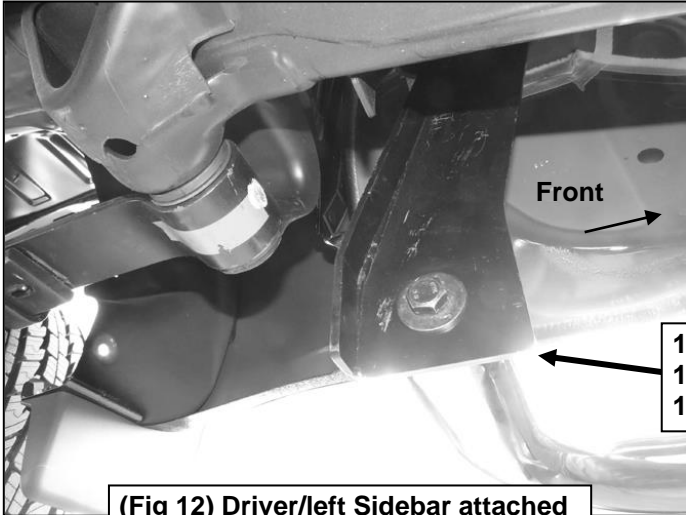

(Fig 12) Driver/left Sidebar attached to the Rear Mounting Bracket

**1/2" x 2" Hex Bolt
1/2" Lock Washer
1/2" Flat Washer**