



**1-800-779-2102**

Mon - Thurs 7:30am - 5:00pm | Friday 7:30am - 4:00pm CST

**PLEASE INSPECT YOUR PRODUCT FOR DAMAGE  
BEFORE PROCEEDING TO INSTALLATION**

**INSTRUCTIONS FOR RETURNS:**

ALL PRODUCTS NEED RETURNED TO THE ORIGINAL POINT OF  
PURCHASE FOR RETURNS, WARRANTY DEFECTS, OR DAMAGE.

FOR MISSING HARDWARE & PARTS,  
PLEASE CONTACT DEE ZEE DIRECTLY.

**[WWW.DEEZEE.COM](http://WWW.DEEZEE.COM)**

REGISTER YOUR PRODUCT ONLINE: [www.deezee.com/registration](http://www.deezee.com/registration)

VIEW INSTRUCTIONS ONLINE: [www.deezee.com/instructions](http://www.deezee.com/instructions)



Thank you for choosing Dee Zee to add function and accessorize your vehicle. Dee Zee has been a staple brand in the truck accessory market since 1977 and we hold a reputation of quality manufacturing based in America's Heartland. Our products are born through careful engineering and backed by industry leading warranty programs. We appreciate the opportunity to serve you and your vehicle!









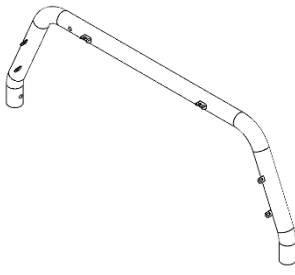
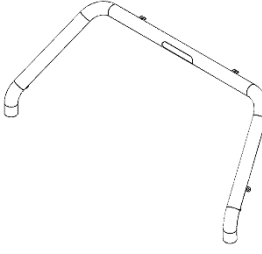
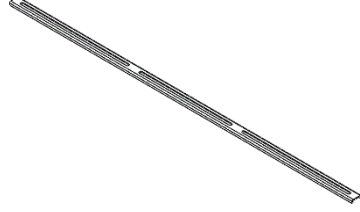
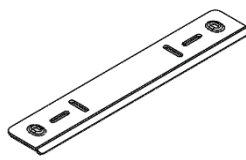

**Review the instruction pages in their entirety to prepare the required tools**

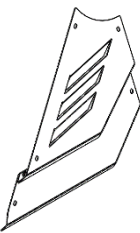
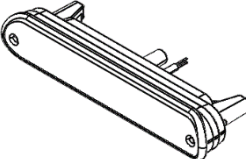
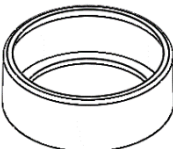

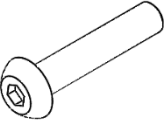

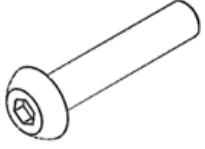

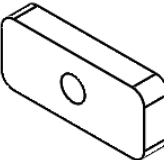

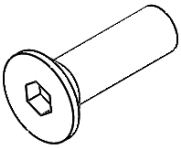
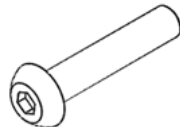

**Note:** This product is an appearance accessory and should not be relied upon as protection for the vehicle occupants in the event of an accident. Buyer assumes all risk, liability, and costs for vehicle impact operations.

Any modifications or unintended use of this product shall immediately void all manufacturers' warranties. Dee Zee, Inc. disclaims all liability for injuries to persons or property resulting from modifications or unintended use of this product. You can review the full warranty policy at [www.deezee.com](http://www.deezee.com).

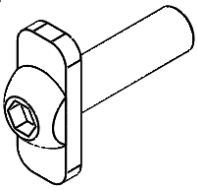
**Cleaning:** To be entitled to all warranty rights offered with the product, Dee Zee sport bars need to be cleaned regularly with a mild detergent. Do NOT use abrasive cleaners.

# Sport Bar DZ 960051B Installation Instructions

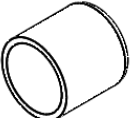
<p><b>A</b> Front Bar</p>  <p style="text-align: right;">X1</p>	<p><b>B</b> Back Bar</p>  <p style="text-align: right;">X1</p>	<p><b>C</b> Top Bracket</p>  <p style="text-align: right;">X1</p>	
<p><b>D</b> Bed Bracket</p>  <p style="text-align: right;">X2</p>	<p><b>E</b> Driver Side Plate</p>  <p style="text-align: right;">X1</p>	<p><b>F</b> Passenger Side Plate</p>  <p style="text-align: right;">X1</p>	
<p><b>G</b> Rear Brake Light</p>  <p style="text-align: right;">X1</p>	<p><b>H</b> Rubber Boot</p>  <p style="text-align: right;">X4</p>	<p><b>I</b> Rubber Grommet</p>  <p style="text-align: right;">X3</p>	
<p><b>J</b> 4mm Allen Head Bolt</p>  <p style="text-align: right;">X2</p>	<p><b>K</b> 4mm Lock Washer</p>  <p style="text-align: right;">X2</p>	<p><b>L</b> 4mm Flat Washer</p>  <p style="text-align: right;">X2</p>	<p><b>M</b> 8mm Allen Head Bolt</p>  <p style="text-align: right;">X2</p>
<p><b>N</b> 8mm Flat Washer</p>  <p style="text-align: right;">X4</p>	<p><b>O</b> Steel block</p>  <p style="text-align: right;">X2</p>	<p><b>P</b> 8mm Lock Washer</p>  <p style="text-align: right;">X2</p>	<p><b>Q</b> 8mm Nut</p>  <p style="text-align: right;">X2</p>

<p><b>R</b> 12mm -1.75 Flat Socket Bolt</p>  <p>X4</p>	<p><b>S</b> 6mm Allen Head Bolt</p>  <p>X10</p>	<p><b>T</b> 6mm Lock Washer</p>  <p>X10</p>	<p><b>U</b> 6mm Flat Washer</p>  <p>X20</p>
<p><b>V</b> 6mm Nut</p>  <p>X10</p>	<p><b>W</b> 12mm Welded Bolt</p>  <p>X4</p>	<p><b>X</b> 12mm Flat Washer</p>  <p>X4</p>	<p><b>Y</b> 12mm Lock Washer</p>  <p>X4</p>
<p><b>Z</b> 12mm Nut</p>  <p>X4</p>	<p><b>AA</b> 12mm Rubber Cover</p>  <p>X4</p>	<p><b>AB</b> 12mm Plastic Washer</p>  <p>X8</p>	

**Tools Required**

**Allen Wrench**  
SUPPLIED

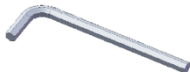

**Drill**  
1/2" Drill Bit



**Ratchet and Socket  
or Wrench**  
10mm  
13mm

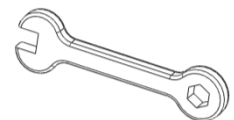

1

Install the rubber grommet (I) in the back bar (B) then feed the wires for the third brake light through the grommet. Then install the third brake light (G) using bolt (J), lock washer (L) and lock washer (K). Fully tighten hardware. Install rubber grommets (I) into the front bar (A) as shown.

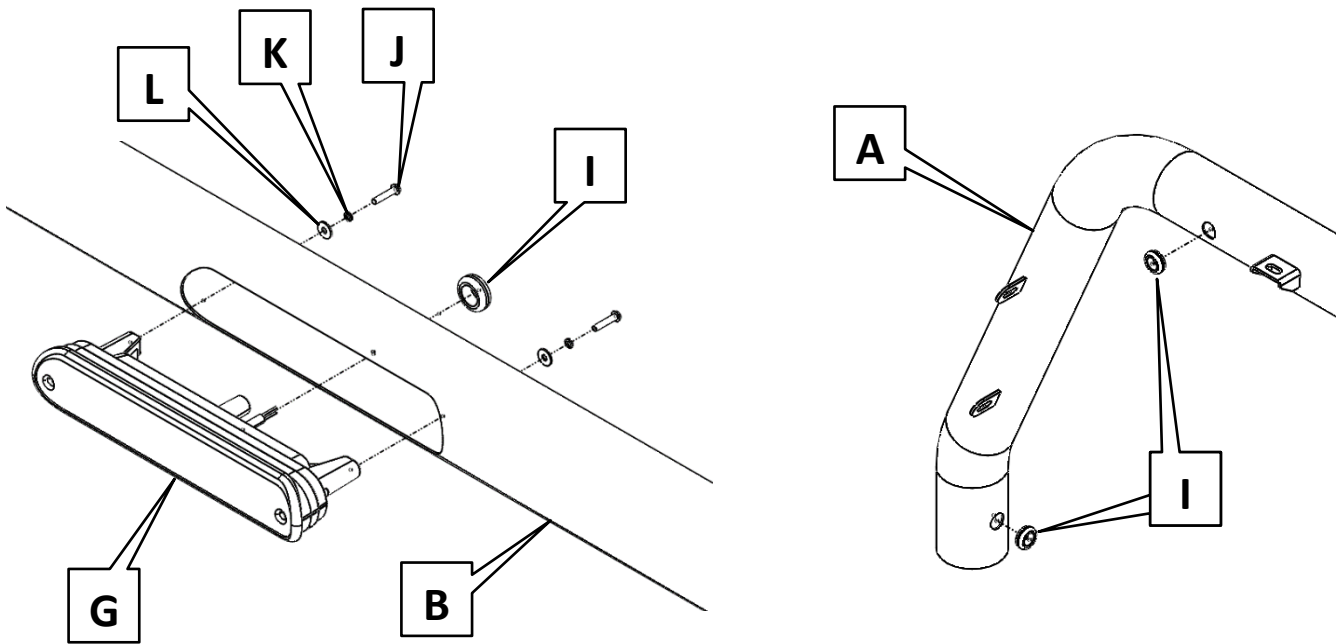

2

Next the front bar (A) and the rear bar (B) need to come together. The rear bar tabs will go underneath the front bar tabs. Place the steel blocks (O) on top of the tabs then install the top bracket (C). Use bolts (M), washers (N), lock washers (P) and nuts (Q) to secure the front bar, rear bar, and top bracket together. Center top bracket and Fully tighten hardware.

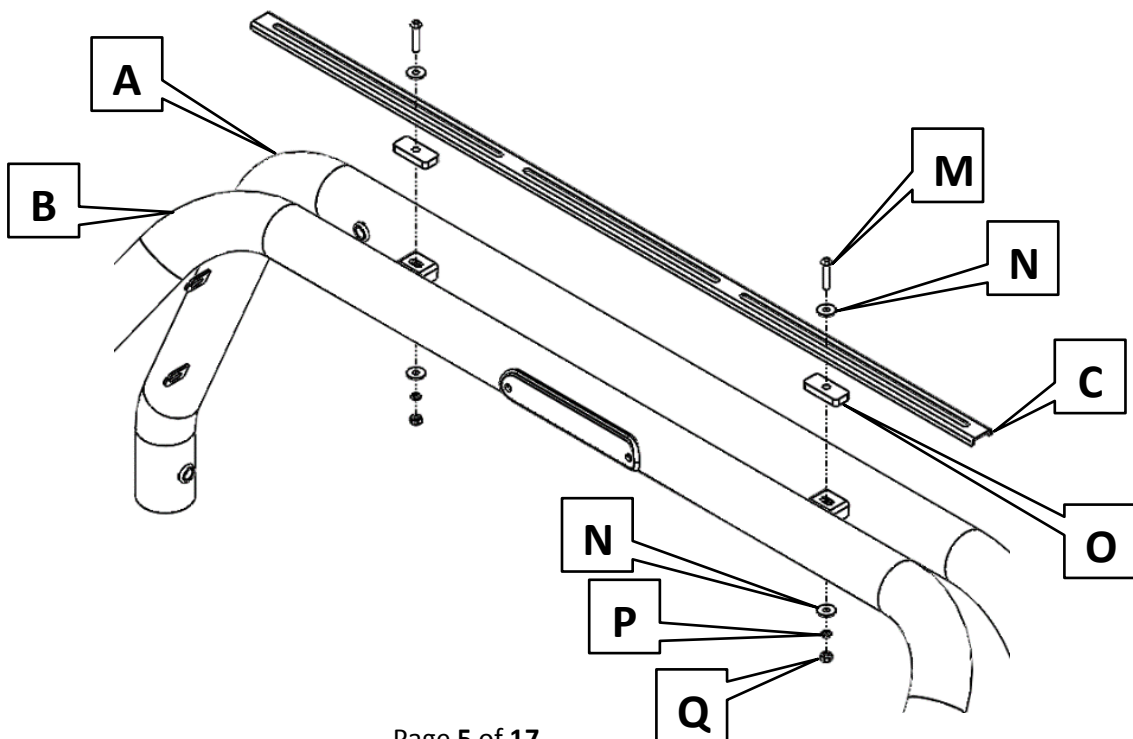

3

Feed the wires from the third brake light to the upper hole of the front bar where the grommet was installed in step 1. Run the wires into the front bar, down to the lower hole of the front bar and bring the wires out of the lower hole.

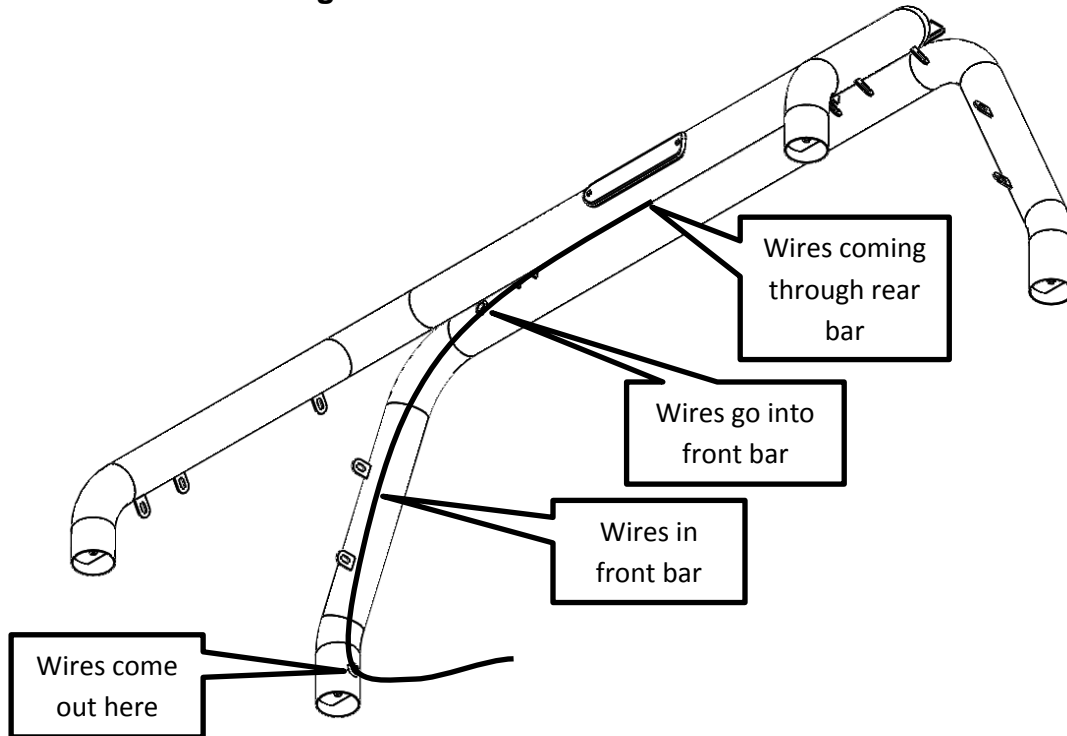

4

Install rubber boots (H) on the ends of the front and rear bars. Then install the bed brackets (D) using bolts (R). Bends on the bed brackets are on the outside of the sport bar and facing down. Do not fully tighten hardware at this time.

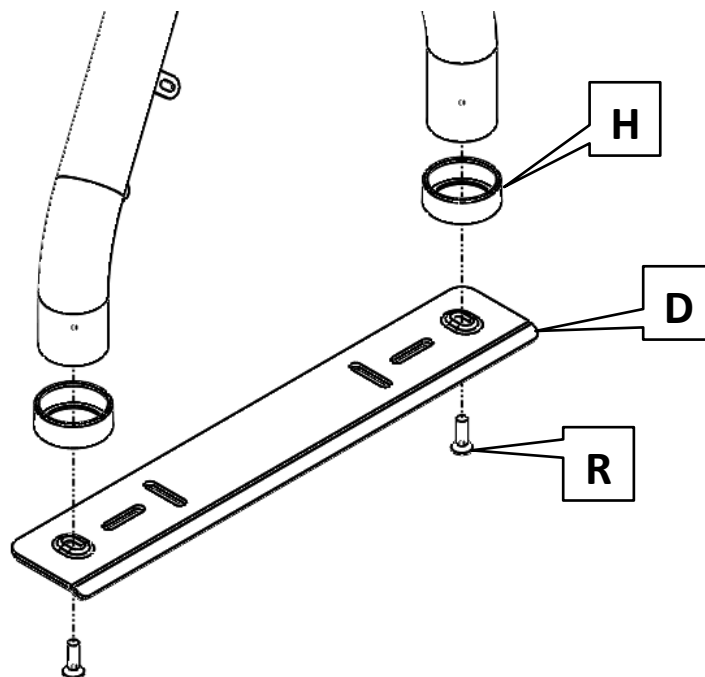

- 5** Install driver side plate (E) by using bolts (S), lock washers (T) flat washers (U) and nuts (V). Then repeat on passenger side using the passenger side plate (F). Fully tighten hardware.

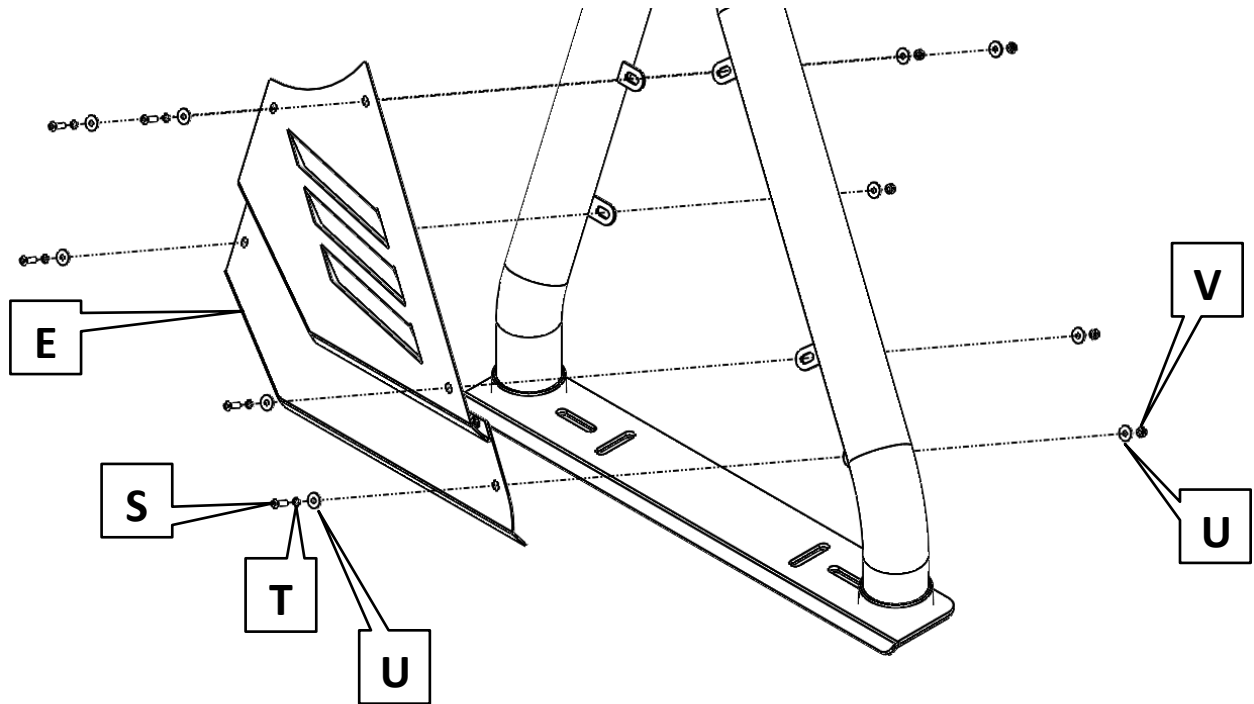

- 6** Place the sport bar assembly on the bed and adjust the bed brackets to desired position. Mark the bed caps in the inner slots of the bed brackets to locate where the holes need to be drilled. Remove the sport bar and fully tighten the bed brackets to the front and rear bars

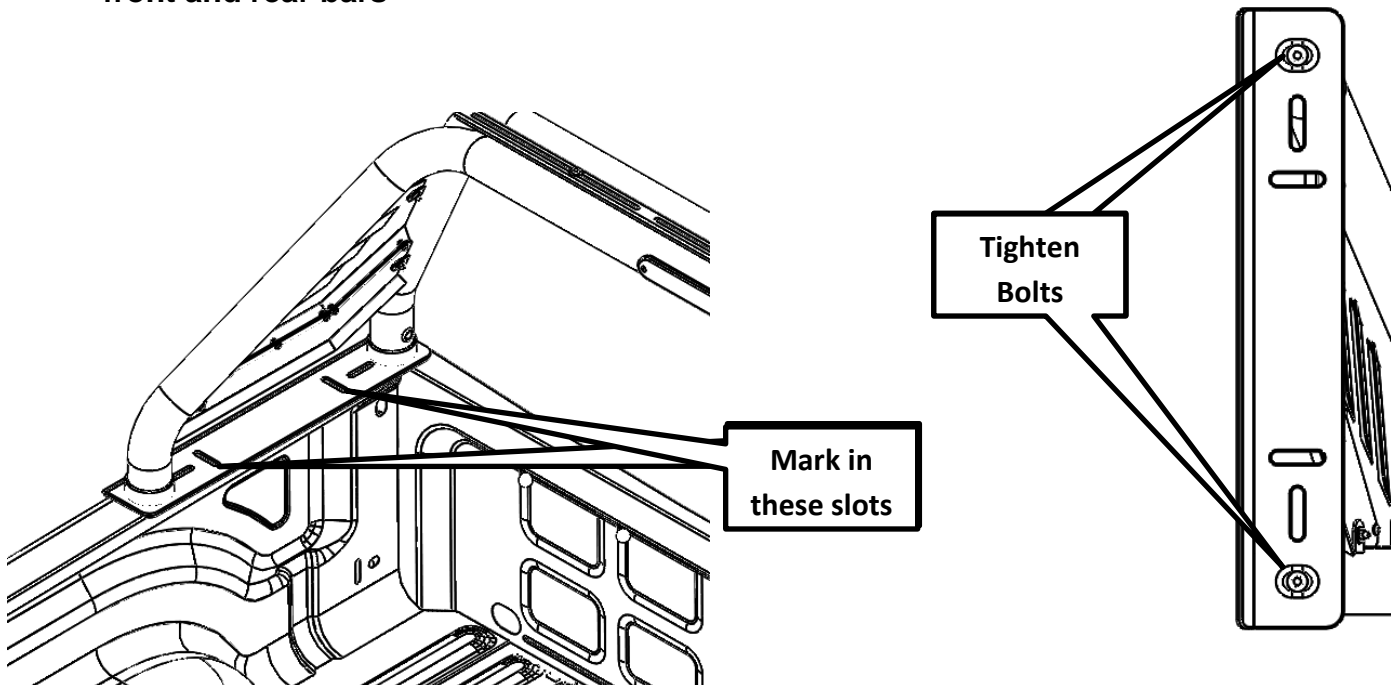

- 7** Drill holes in the middle of the marks that were made in step 6. Once the holes are drilled, place the sport bar back onto the truck bed and line up the holes with the slots.



**Drill Holes**

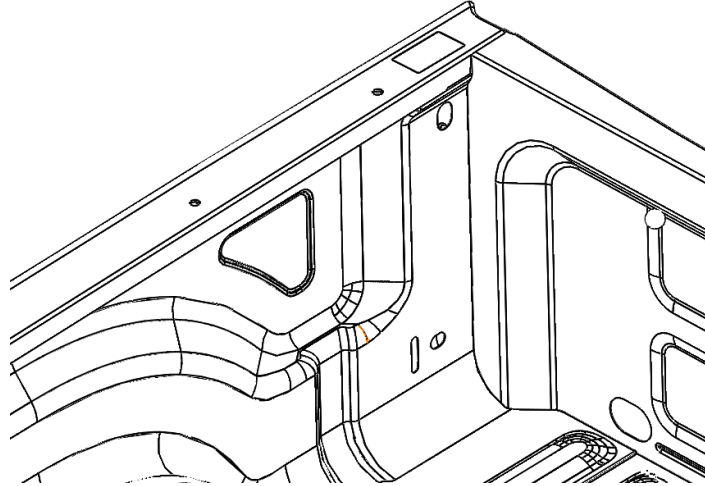

- 8** Install sport bar assembly using bolt (W), plastic washer (AB), washer (X), lock washer (Y) and nut (Z). Center the sport bar and fully tighten hardware at this time. Then install the rubber cover (AA) onto nut (Z).

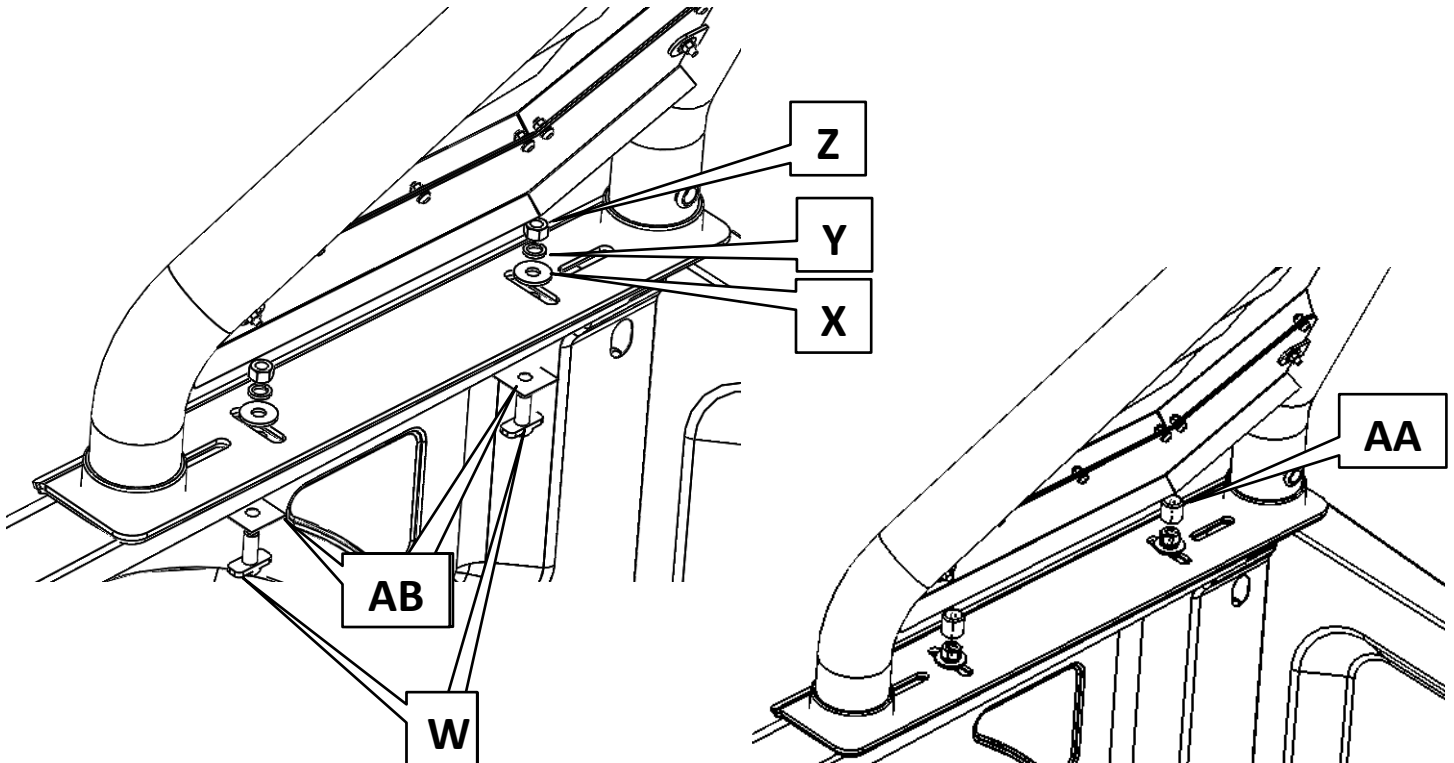





## Sport Bar Wiring Instructions

Find your make and model year then go to the page listed. For the most recent revision of color instructions visit [www.deezee.com/instructions/](http://www.deezee.com/instructions/)

Make	Year	Go to Page
Dodge Ram 1500	2002-2008	10
Dodge Ram 1500	2009-2018	12
Dodge Ram 2500	2003-2009	14
Dodge Ram 2500	2010-2018	16

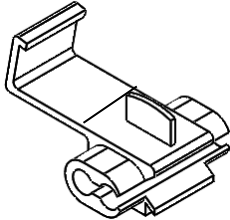
### Sport Bar Wiring Hardware

<b>A</b> ¼" Eyelet  X1	<b>B</b> Scotch lock  X1	<b>C</b> Zip-ties  X8
<b>D</b> Wire loom  X15 Ft		

#### Tools Required

Wire Crimper

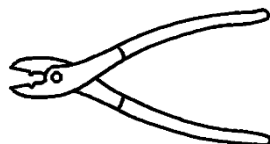

Wire Stripper

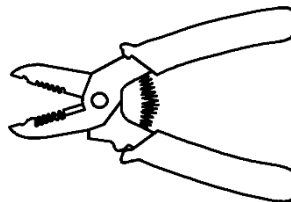

## Dodge Ram 1500 2002-2008 Wiring Instructions

- 1 Run the Red wire of the CHMSL light through the stake pocket and back towards the rear of the vehicle. Locate the White with Tan Stripe wire coming off of a wire loom on the driver side frame.

**White  
with Tan  
Stripe**

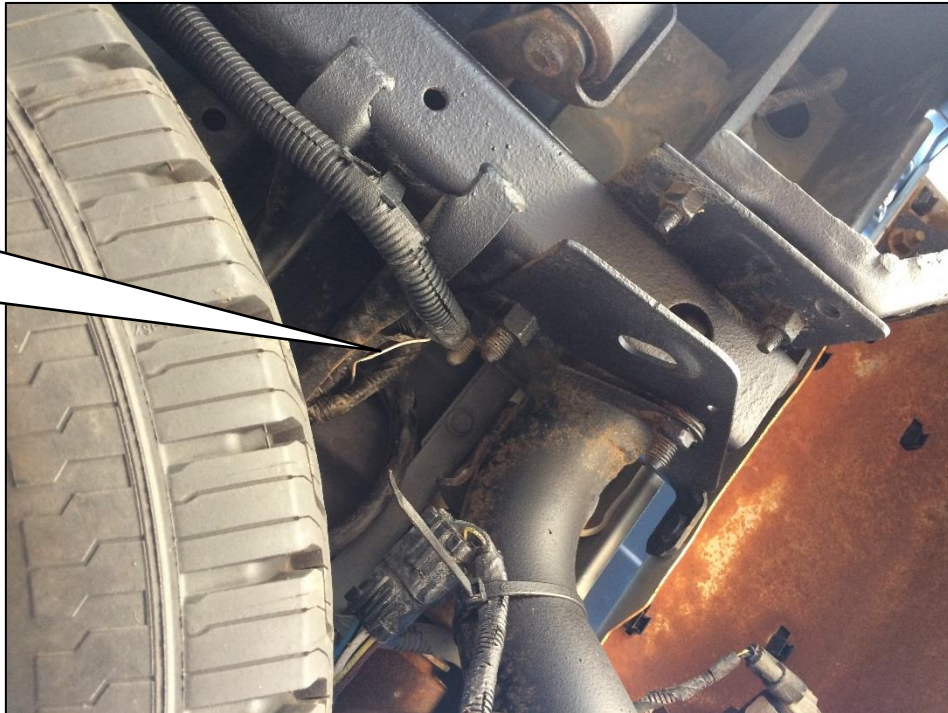

- 2 Run the Black wire of the CHMSL light through the stake pocket down towards the frame of the truck and locate the ground bolt as shown.

**Bolt**



- 3** Use the scotch lock (B) to connect the White with Tan Stripe wire and the Red wire of the CHMSL light. Insert the White with Tan Stripe wire into the outer slot of the scotch lock and insert the Red wire into the blunt end of the Scotch lock. Then fold over the plastic cover and crimp the Scotch lock together.

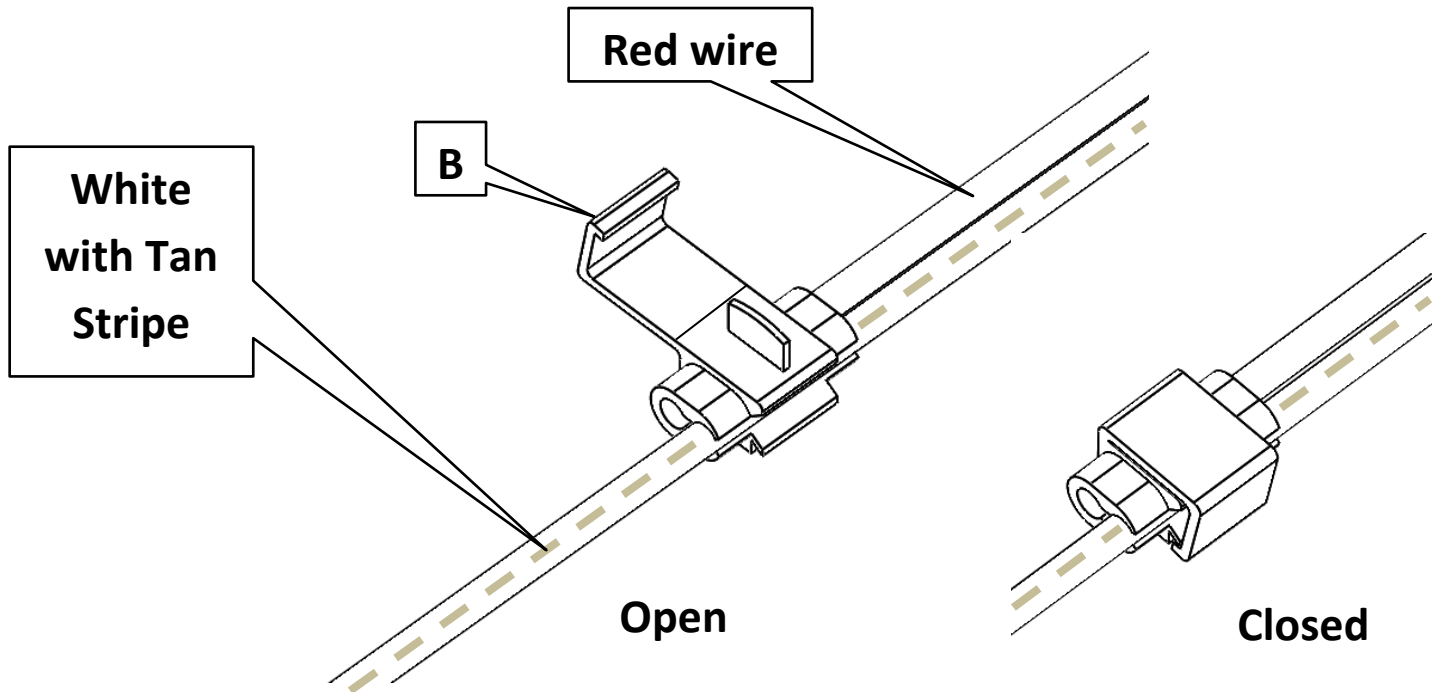

- 4** Strip the end of the Black wire of the CHMSL light and crimp the  $\frac{1}{4}$ " eyelet (A) onto the Black wire. Remove the ground bolt from step 2 and add the eyelet. Reinstall the bolt.

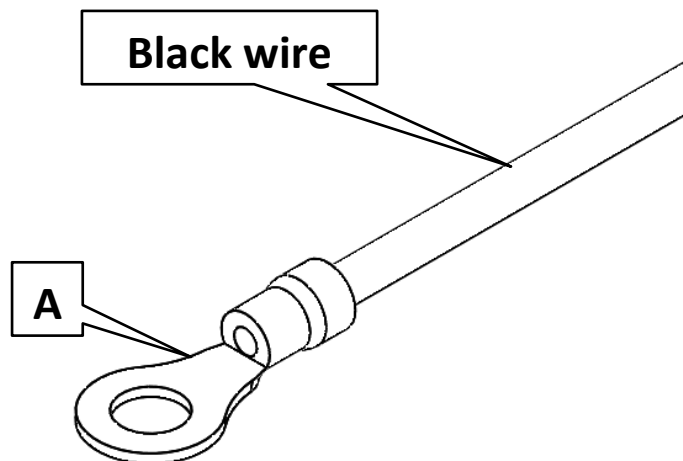

Use Wire Loom (D) and Zip-ties (C) to cover and hold up wires where preferred.

## Dodge Ram 1500 2009-2018 Wiring Instructions

- 1 Run the Red wire of the CHMSL light through the stake pocket and back towards the rear of the vehicle. Locate the White with Purple Stripe wire taped onto a wire loom on the driver side frame.

White with  
Purple Stripe



- 2 Run the Black wire of the CHMSL light through the stake pocket down towards the frame of the truck and locate the ground stud as shown.

Stud



- 3** Use the scotch lock (B) to connect the White with Purple Stripe wire located in step 1 and the Red wire of the CHMSL light. Insert the White with Purple Stripe wire into the outer slot of the scotch lock and insert the Red wire into the blunt end of the Scotch lock. Then fold over the plastic cover and crimp the Scotch lock together.

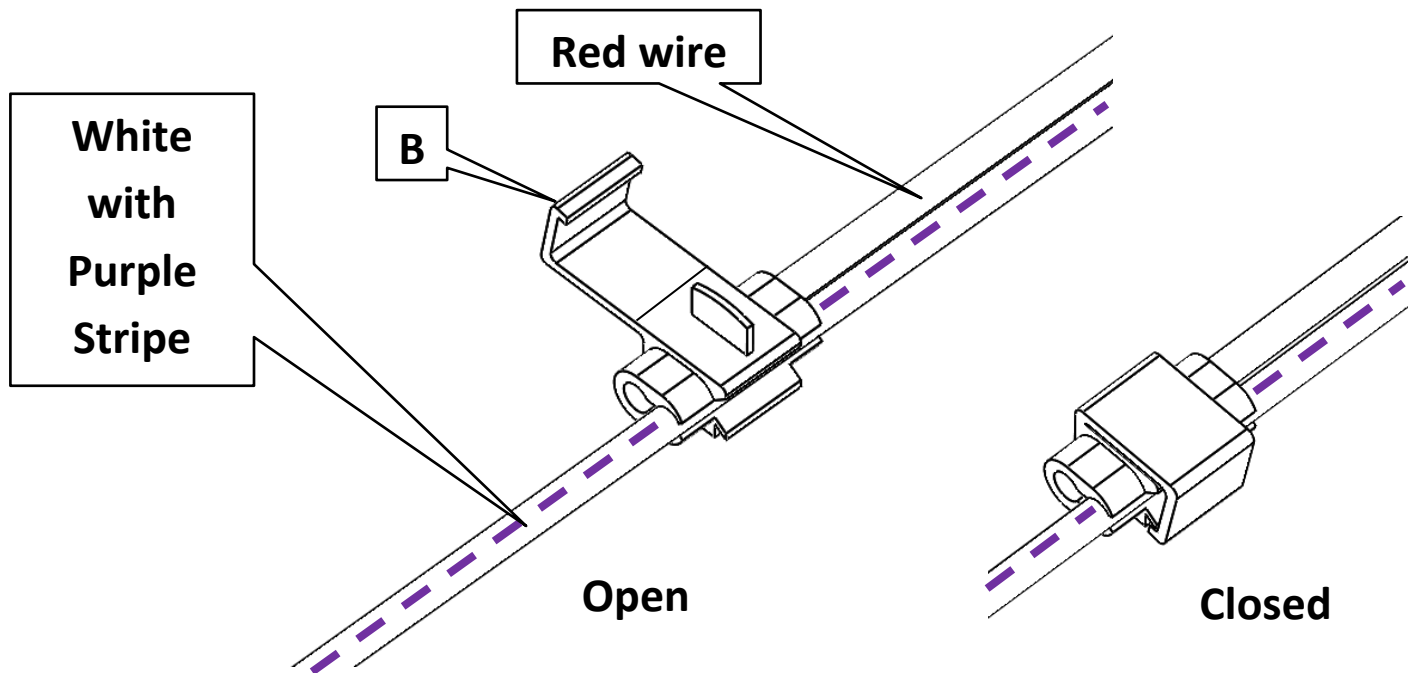

- 4** Strip the end of the Black wire of the CHMSL light and crimp the  $\frac{1}{4}$ " eyelet (A) onto the Black wire. Remove the ground nut from step 2 and add the eyelet. Reinstall the bolt.

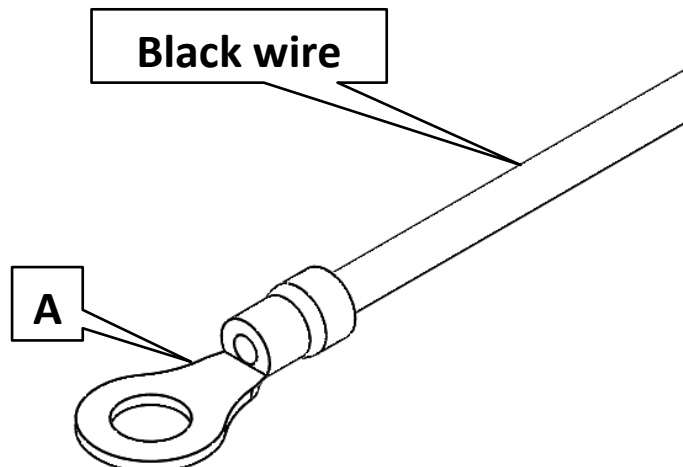

Use Wire Loom (D) and Zip-ties (C) to cover and hold up wires where preferred.

## Dodge Ram 2500 2003-2009 Wiring Instructions

- 1 Run the Red wire of the CHMSL light through the stake pocket and back towards the rear of the vehicle. Locate the White with Tan Stripe wire coming off of a wire loom on the driver side frame.

White with  
Tan Stripe



- 2 Run the Black wire of the CHMSL light through the stake pocket down towards the frame of the truck and locate the ground stud as shown.

Stud

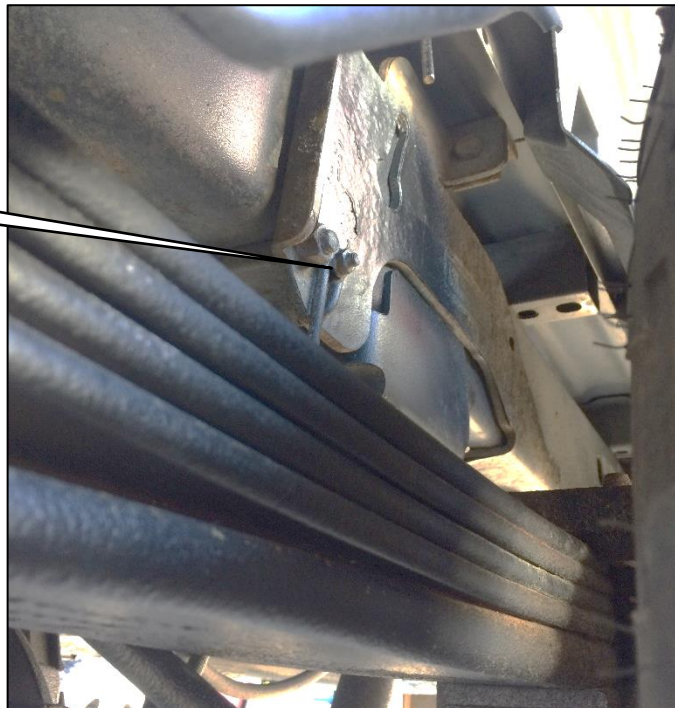

**3**

Use the scotch lock (B) to connect the White with Tan Stripe wire located in step 1 and the Red wire of the CHMSL light. Insert the White with Tan Stripe wire into the outer slot of the scotch lock and insert the Red wire into the blunt end of the Scotch lock. Then fold over the plastic cover and crimp the Scotch lock together.

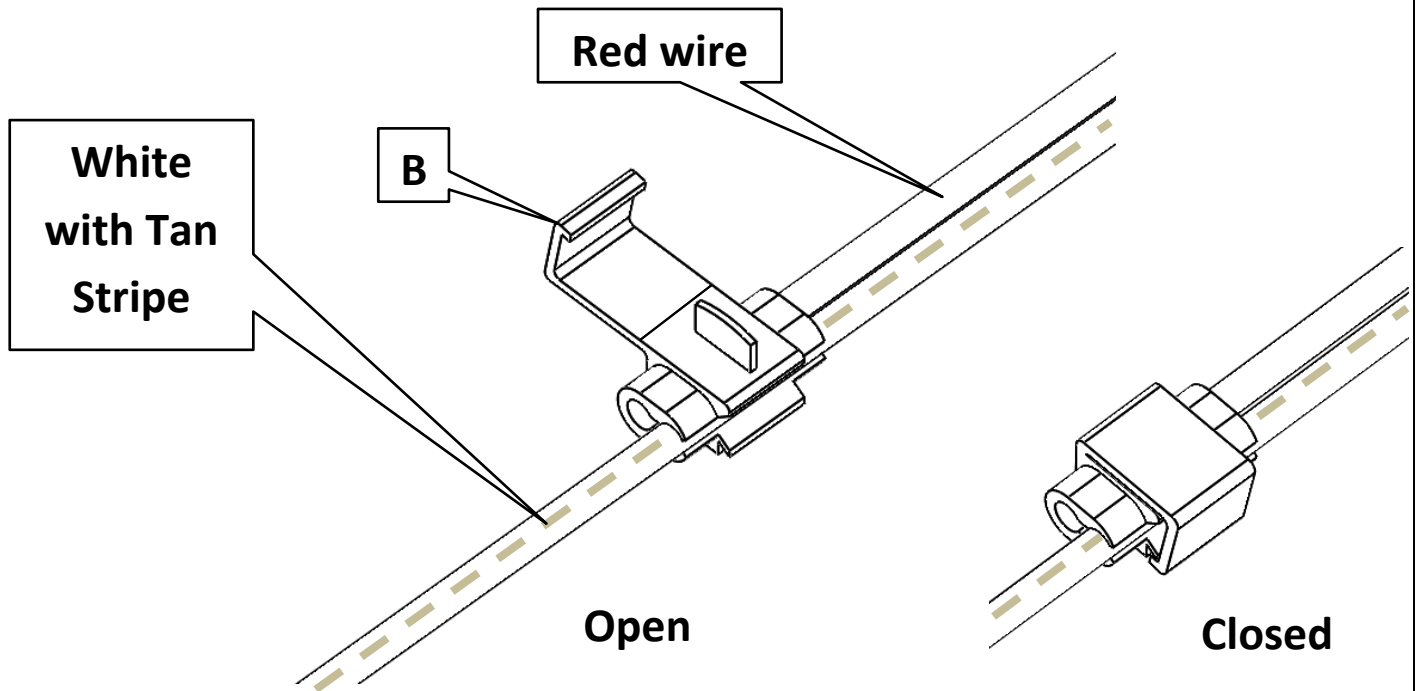

Strip the end of the Black wire of the CHMSL light and crimp the  $\frac{1}{4}$ " eyelet (A) onto the Black wire. Remove the ground nut from step 2 and add the eyelet. Reinstall the bolt.

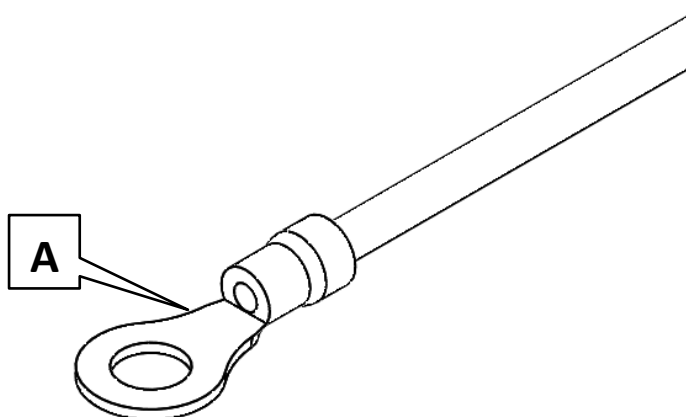

Use Wire Loom (D) and Zip-ties (C) to cover and hold up wires where preferred.

## Dodge Ram 2500 2009-2018 Wiring Instructions

- 1 Run the Red wire of the CHMSL light through the stake pocket and back towards the rear of the vehicle. Remove the spare tire and locate the White with Purple Stripe wire taped onto a wire loom on the rail connecting the main frames together.

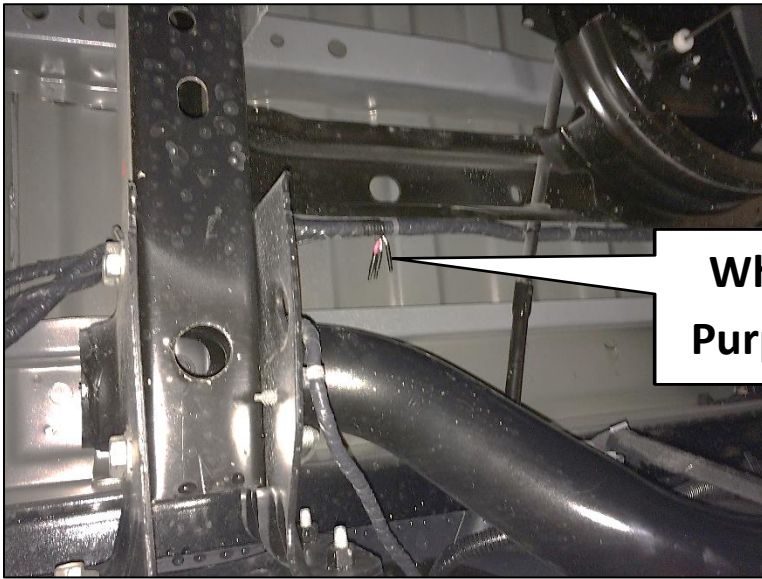

White with  
Purple Stripe

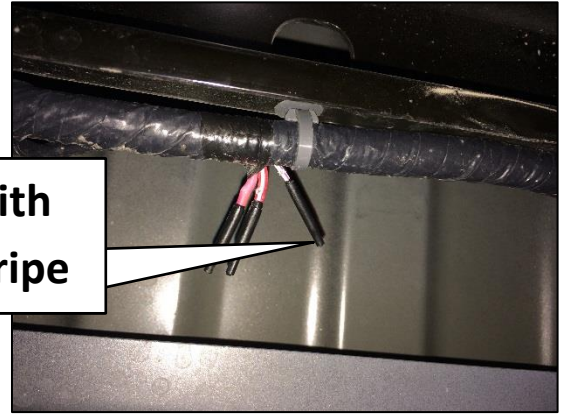

- 2 Run the Black wire of the CHMSL light through the stake pocket down towards the frame of the truck and locate the ground stud as shown.

Stud





- 3** Use the scotch lock (B) to connect the White with Purple Stripe wire located in step 1 and the Red wire of the CHMSL light. Insert the White with Purple Stripe wire into the outer slot of the scotch lock and insert the Red wire into the blunt end of the Scotch lock. Then fold over the plastic cover and crimp the Scotch lock together.

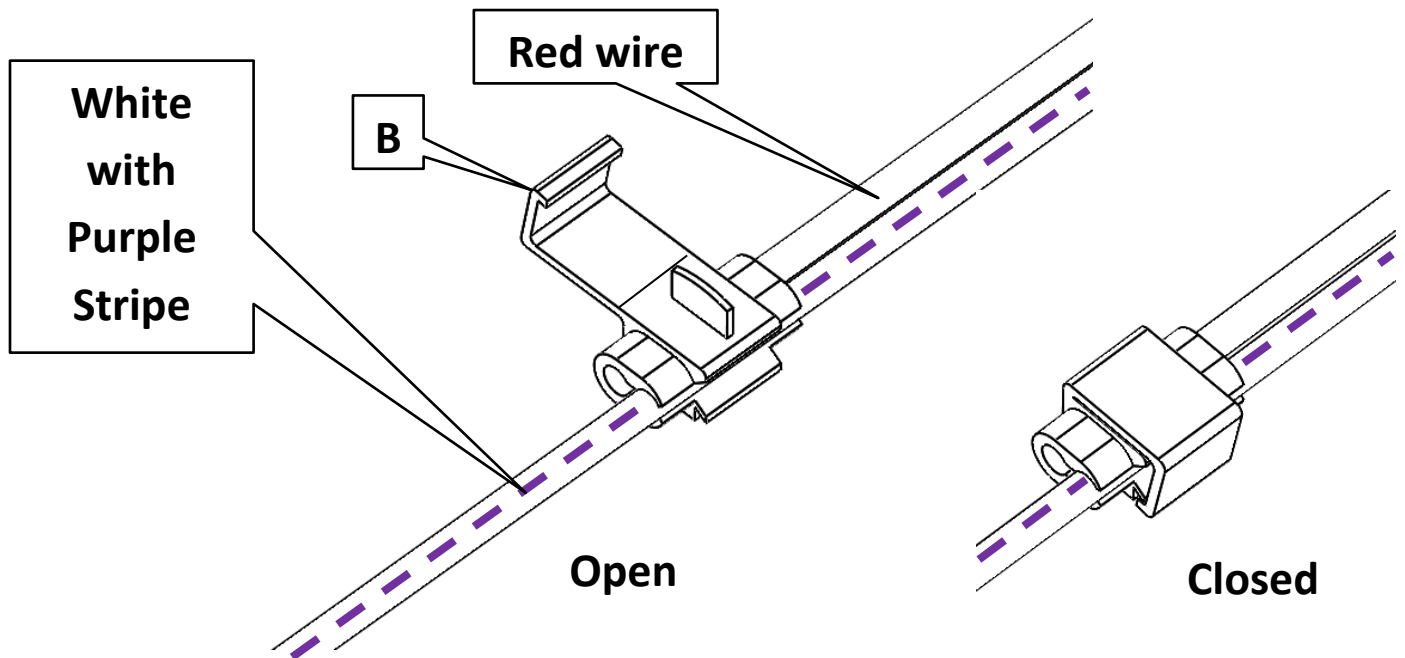

- 4** Strip the end of the Black wire of the CHMSL light and crimp the  $\frac{1}{4}$ " eyelet (A) onto the Black wire. Remove the ground nut from step 2 and add the eyelet. Reinstall the bolt.

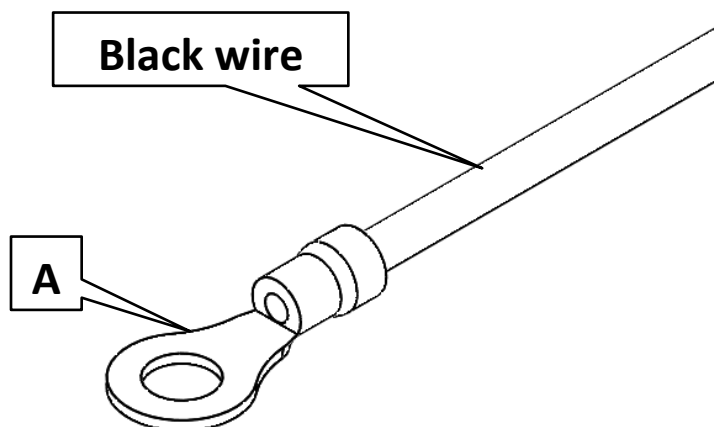

Use Wire Loom (D) and Zip-ties (C) to cover and hold up wires where preferred.